

W1000 READOUTS

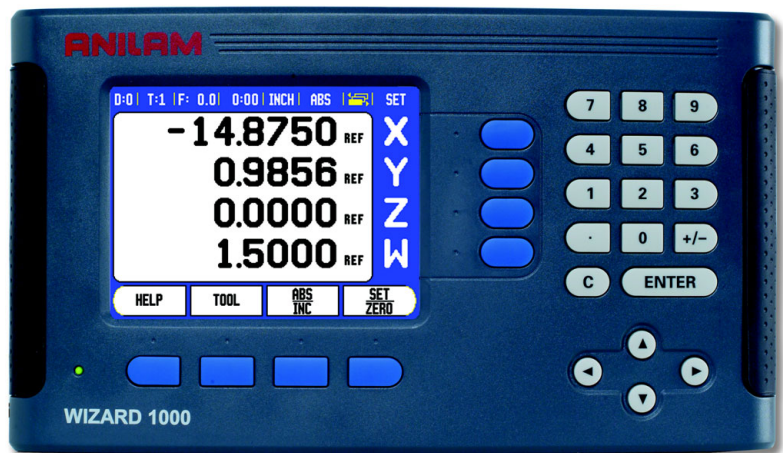

ANILAM

REFERENCE MANUAL

W1000 Key Layout

- 1 Display Area
- 2 Soft keys
- 3 Power Indicator light
- 4 Arrow Keys: Use the UP/DOWN keys to adjust the screen contrast.
- 5 Axis Keys
- 6 Numeric Keypad
- 7 ENTER key
- 8 CLEAR key

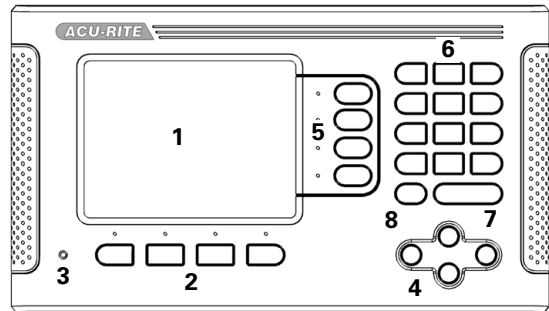

W1000 Soft keys



There are multiple pages of soft key functions to select from the operating modes. Use the LEFT/RIGHT arrow keys -4- to cursor through each page. The page indicator in the Status Bar will show the page orientation. The darkened page indicates the page you are currently on.



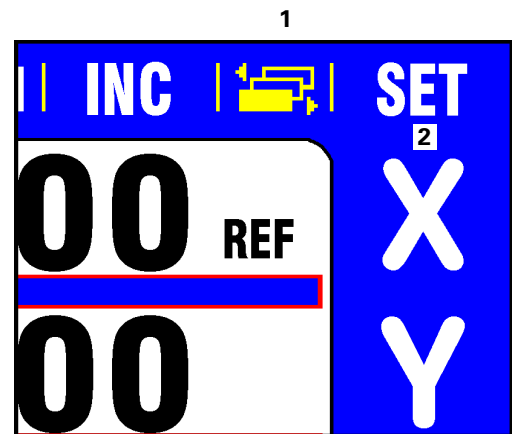

- 1 Page Indicator
- 2 Set Zero Indicator

Soft Key function (Page 1)	Soft key
Opens on-screen help instructions.	
Opens the Tool Table. Page 22 for Milling, and page 51 for Turning.	
Switches display between operating modes Actual Value (Absolute) / Distance-to-Go (incremental). See page 12.	
Toggles between Set/Zero functions. Used with individual axis keys (page 20).	

Soft Key function (Page 2a)	Soft key
Opens the Datum form to set the datum for each axis (page 28).	
Opens the Preset form. This form is used to set a nominal position. This is a Distance-To-Go (Incremental) function (page 33).	
Used to divide the current position by two (page 36).	

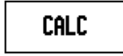

Soft Key function (Page 2a)	Soft key
Press to select the Circle Pattern, Linear Pattern, Incline Mill, or Arc Mill table (page 38).	
This soft key toggles between radius and diameter displays. This function is for Turning applications only (page 56).	

Soft Key function (Page 2b)	Soft key
Opens the Job Setup menu and provides access to the Installation Setup soft key (page 13).	
Press when ready to identify a reference mark (page 10).	
Opens the Calculator functions for standard math, trigonometry, RPM, and Taper for Turning functions. The CALC key is also available on input forms where calculations may be required while inputting data.	
Toggles between inch and millimeter units (page 13).	

Soft Key function (Page 3)	Soft key
Selects the Program Mode (page 66).	

Readout Parameter Access Code

An access code must be entered before machine-related installation parameters can be set or changed. This prevents inadvertent adjustments to the installation setup parameters.

**IMPORTANT!**

The access code is 8891.

Access to Machine Parameter Operations

Refer to the Setup section also.

 **SETUP**

Begin by pressing the SETUP soft key.

Press the soft key INSTALLATION SETUP.

Press the access code numbers **8891** using the numeric key pad.

 **ENTER**

Press the ENTER key

The readout is now ready for machine parameter setting operations.

**IMPORTANT!**

To prevent setup parameters from being changed, remove this page from the Reference Manual after initially setting up the readout system. Retain this information in a safe place for future use.



Introduction

Software Version

The software version is shown on the initial power up screen.



This User's Manual covers the functions of the W1000 for both **milling**, and **turning** applications. Operational information is arranged in three sections: General Operations, Mill Specific Operations, and Turn Specific Operations.

W1000

DRO axis availability.



The W1000 Color DRO is available in **two**, **three**, and **four axis** form. The 4 axis W1000 DRO is used through out this manual for illustration, and description of function keys.

Symbols within Notes

Every note is marked with a symbol on the left indicating to the operator the type, and/or potential severity of the note.



General Information

e.g. on the behavior of the W1000.



Warning

e.g. when a special tool is required for a function.



Damage - Risk of electric shock

e.g. when opening a housing.

W1000 Fonts

The following shows how soft keys, and hard keys are represented within the text of this manual:

- Soft keys - SETUP soft key
- Hard keys - ENTER hard key

Warranty

For warranty information go to www.anilam.com



Table of Contents

- W1000 Key Layouti
- W1000 Soft keysi
- Readout Parameter Access Code
 - Access to Machine Parameter Operations iii
- Introduction
 - Software Versionv
 - W1000v
 - Symbols within Notes.....v
 - W1000 Fontsv
- Warranty
 - Warrantyvii
- I - 1 Fundamentals of Positioning
 - Datums 2
 - Actual Position, Nominal Position, and Distance-To-Go..... 2
 - Absolute Workpiece Positions 3
 - Incremental workpiece positions..... 3
 - Zero Angle Reference Axis 4
 - Reading head position 4
 - Encoder Reference Marks 5
- I - 2 General Operations for W1000
 - Screen Layout 6
 - General Navigation..... 7
 - General Overview 7
 - Graphic Positioning Aid..... 7
 - Help Screen 8
 - Data Input Forms 9
 - Instruction Box messages 9
 - Error Messages..... 9
 - Power Up..... 10
 - Reference Mark Evaluation..... 10
 - Working without reference mark evaluation..... 10
 - Enable/Disable Ref function..... 11
 - Operating Modes 12
 - Setup 12

Job Setup Parameters	13
Units	13
Scale Factor	13
Mirror	14
Edge Finder (milling applications only)	14
Diameter Axes	14
Measured Value Output	15
Near Zero Warning	15
Status Bar Settings	15
Job Clock	15
Skew Compensation (Milling applications only)	16
Remote Switch	17
DRO View Settings	17
Console Adjustment	19
Language	19
Import/Export	19
Set/Zero Soft Key Details	20
Calc Soft Key	20
RPM Calculator	21

I - 3 Milling Specific Operations

Soft Key Functions Detailed	22
Tool Soft Key	22
Tool Table	22
Import/Export	23
Tool Radius Compensation feature	24
Sign for the length difference ΔL	24
Entering tool data	25
Calling the Tool from the Tool Table	28
Datum Soft Key	28
Probing Functions for Datum Setting	28
Probing with a Tool	31
Example: Probe workpiece edge and set edge as datum	32
Presets	33
Absolute Distance Preset	33
Incremental Distance Preset	35
1/2 Soft Key	36
Features (Milling)	37
Circle, and Linear Patterns	38
Soft key Functions	38
Circle, and Linear Pattern Table Entry	39
Circle, and Linear Pattern Soft keys	40
Circle, or Linear Pattern Execution	41
Example: Enter data and execute a circle pattern.	42
Incline, and Arc Milling	44
Soft Key Functions	44
Incline, and Arc Milling Table Entry	45

Incline, and Arc Milling Table Entry	46
Arc Milling	47
Incline, and Arc Mill Execution	48
Z/W Coupling	50
Enabling Z/W Coupling.....	50
Disabling Z/W Coupling.....	50

I - 4 Turning Specific Operations

Tool Display Icon	51
Tool Table.....	51
Datum Setting.....	53
Taper Calculator Soft Key.....	55
Presets.....	56
Radius/Diameter Soft Key	56
Vectoring.....	57
Z Coupling	57
Disabling Z0, and Z Coupling.....	58
Thread Cycle	59
Soft Key Functions.....	59
Running the Thread Cycle Program	64

I - 5 Programming W1000

Overview	66
Program Mode Soft key functions	67
View Soft Key	68
Feature Soft Key functions	69
Program Function Soft keys	71
Step Function Soft keys.....	72
Editing, and moving through a program.....	73

I - 6 Executing a Program

Run Soft Keys	74
Executing Steps.....	74

II - 1 Installation Setup

Installation Setup Parameters	78
Encoder Setup	79
Thread Cycle Setup:.....	80
Display Configuration	81
Error Compensation.....	81
Linear Error Compensation	82
Automatic Linear error compensation.....	82
Non-Linear Error Compensation.....	83
Setup procedure for Non-linear Error	83

Starting a Non-Linear Error Compensation Table	84
Configuring the Compensation Table	85
Automatic Non Linear error compensation	85
Backlash Compensation	87
Counter Settings	87
Diagnostics	88
Keypad Test	88
Edge Finder Test.....	88
Display Test	88
II - 2 Data Interface	
Serial Port	90
II - 3 Installation and Electrical Connections	
Installation.....	91
Electrical requirements	91
Environmental.....	91
Preventative maintenance	91
II - 4 I/O Connections	
Wiring the Serial communication cable	93
II - 5 Remote Switch Data Output	
Data output using external signals.....	94
Data output using Edge Finder	96
II - 6 Error Messages	
.....	99
II - 7 Dimensions	
DRO Dimensions	102

W1000



Operating Instructions

I - 1 Fundamentals of Positioning

Datums

The workpiece drawing identifies a certain point on the workpiece (example: "a corner") as the absolute datum, and perhaps one, or more other points as relative datums.

The datum setting procedure establishes these points as the origin of the absolute, or relative coordinate systems. The workpiece, which is aligned with the machine axes, is moved to a certain position relative to the tool. The display is set either to zero, or to another appropriate value (e.g., to compensate for tool radius).

Actual Position, Nominal Position, and Distance-To-Go

The position of the tool at any given moment is called the ACTUAL POSITION **I**, while the position that the tool is to move to is called the NOMINAL POSITION **S**. The distance from the nominal position to the actual position is called the DISTANCE-TO-GO **R**.

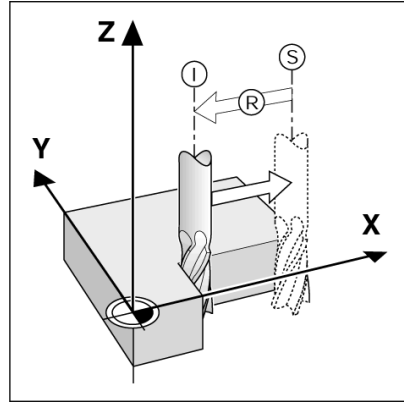

Absolute Workpiece Positions

Each position on the workpiece is uniquely identified by its absolute coordinates.

Example: Absolute coordinates of position **1**:

X = 20 mm

Y = 10 mm

Z = 15 mm

If you are drilling, or milling a workpiece according to a workpiece drawing with **absolute coordinates**, the tool is moving to the value of the coordinates.

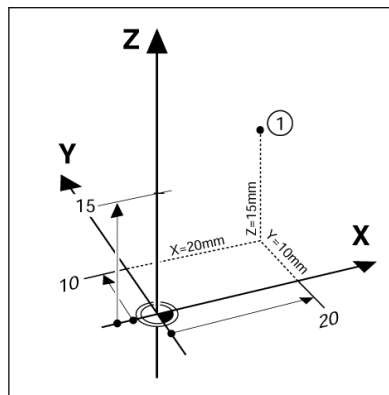

Incremental workpiece positions

A position can also be referenced to the preceding nominal position. In this case the relative datum is always the last nominal position. Such coordinates are referred to as **incremental coordinates** (increment = increase). They are also called incremental, or chain dimensions, since the positions are defined as a chain of dimensions. Incremental coordinates are designated with the prefix **I**.

Example: Incremental coordinates of position **3** referenced to position **2**.

Absolute coordinates of position **2**:

X = 10 mm

Y = 5 mm

Z = 20 mm

Incremental coordinates of position **3**:

IX = 10 mm

IY = 5 mm

IZ = 20 mm

If you are drilling, or milling a workpiece according to a drawing with incremental coordinates, you are moving the tool **by** the value of the coordinates.

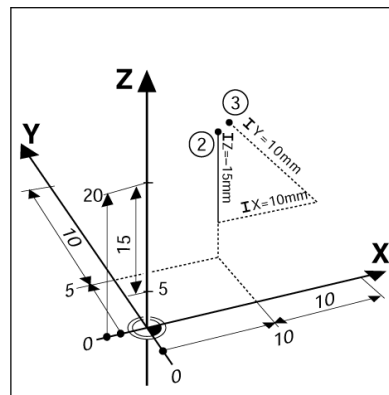

Zero Angle Reference Axis

The Zero Angle Reference Axis is the 0.0° position. It is defined as one of the two axes in the plane of rotation. The following table defines the Zero Angle where the position of the angle is zero for the three possible planes of rotation.

For angular positions, the following reference axes are defined:

Plane	Zero Angle Reference Axis
XY	+X
YZ	+Y
ZX	+Z

Positive direction of rotation is counterclockwise if the working plane is viewed in the negative tool axis direction.

EXAMPLE: Angle in the working plane X / Y

Plane	Zero Angle Reference Axis
+ 45°	... bisecting line between +X and +Y
+/- 180°	... negative X axis
- 270°	... positive Y axis

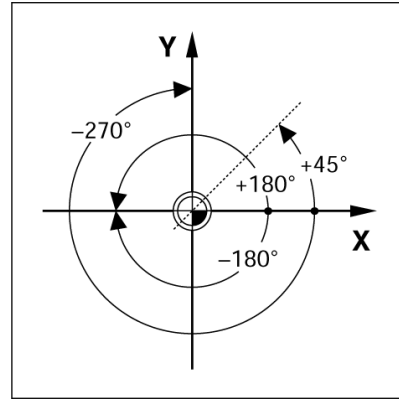

Reading head position

The reading head position provides feed back to the W1000 that converts the movement of the machine axes into electrical signals. The W1000 constantly evaluates these signals, and calculates the actual positions of the machine axes, which it displays as a numerical value on the screen.

If there is an interruption in power, the calculated position will no longer correspond to the actual position. When power is restored, you can re-establish this relationship by using the reference marks on the provided on the scale. The W1000 provides the Reference Mark Evaluation feature (**REF**).

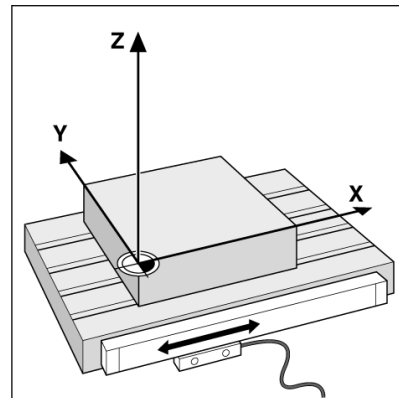

Encoder Reference Marks

Encoders normally contain one or more reference marks which the W1000 Reference Mark Evaluation feature uses to re-establish datum positions after a power interruption. There are two main options available for reference marks; fixed and distance-coded.

Position Trac (Distance-coded reference marks): Encoders that have marks separated by a specific encryption pattern allows the W1000 to use any two pair of marks along the length of the encoder to re-establish the prior datums. This configuration means that the operator only has to travel less than two inches any where along the encoder, to re-establish the datums when the W1000 is turned back on.

Fixed reference marks: Encoders that have one or more marks on fixed intervals, have to re-establish the datums correctly. It is necessary to use the same exact reference mark, during the Reference Mark Evaluation routine, that was used when the datum was first established.

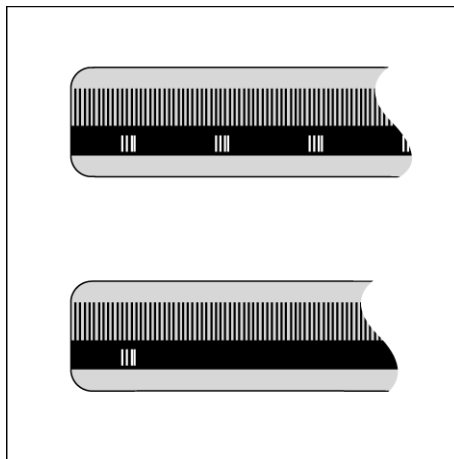

The established datums' cannot be restored from one power cycle to the next if the reference marks were not crossed before the datums were set

I - 2 General Operations for W1000

Screen Layout

- 1 Datum
- 2 Tool
- 3 Feed Rate
- 4 Job Clock
- 5 Unit of Measure
- 6 Operating Modes
- 7 Page Indicator
- 8 Set/Zero
- 9 Axis Labels
- 10 Ref Symbol
- 11 Soft key Labels
- 12 Display Area
- 13 Near Zero Warning (In Distance-To-Go mode only)

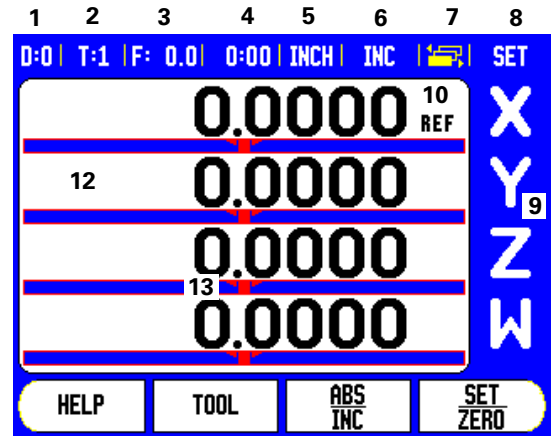

11

The Anilam W1000 color readout provides application-specific features that allows you to obtain the most productivity from your manual machine tools.

- **Status Bar** - This displays the current datum, tool, feed rate, job clock time, unit of measure, operating mode status, page indicator, and set/zero. See Job Setup for details on setting up the Status Bar parameters.
- **Display Area** - Indicates the current position of each axis. Also shows forms, fields, instruction boxes, error messages and help topics.
- **Axis Labels** - Indicates axis for corresponding axis key.
- **Ref Symbols** - Indicates current reference mark status.
- **Soft key Labels** - Indicates the various milling or turning functions.

General Navigation

- Use key pad to enter numeric values within each field.
- The ENTER key will confirm the entry within a field, and return to the previous screen.
- Press the C key to clear entries, and error messages, or return back to the previous screen.
- SOFT KEY labels show the various milling, or turning functions. These functions are selected by pressing the corresponding soft key directly below each soft key label. There are 3 pages of selectable soft key functions. These are accessed using the LEFT or RIGHT arrow keys as indicated below.
- LEFT or RIGHT arrow keys move through pages 1-3 of soft key selectable functions. The current page will be highlighted in the Status bar at the top of screen.
- Use the UP, or DOWN arrow keys to move between fields within a form, and list boxes within a menu. The orientation of the cursor is such that it will return to the top once it has reached the bottom of a menu.

General Overview

Graphic Positioning Aid

When traversing to display value zero (in the Distance-To-Go mode), W1000 displays a graphic positioning aid.

W1000 displays the graphic positioning aid in a narrow rectangle underneath the currently active axis. Two triangular marks in the center of the rectangle symbolize the nominal position.

A small square symbolizes the axis slide. An arrow indicating the direction appears in the square while the axis is moving towards, or away from the nominal position. Note that the square does not begin to move until the axis slide is near the nominal position. Setting up the graphic positioning aid, see "Status Bar Settings" on page 15 under Job Setup.

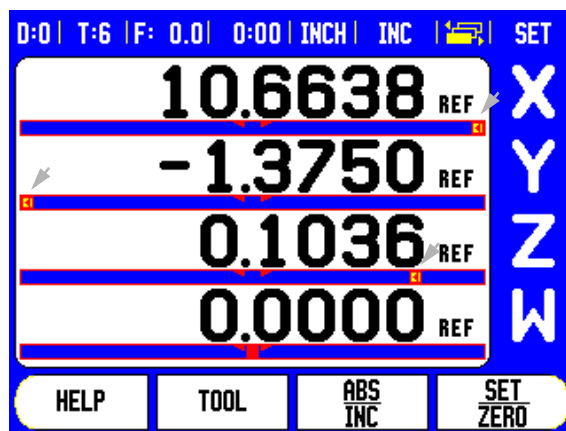

Help Screen

The integrated operating instructions provide information and assistance in any situation.

To call the operating instructions:

- ▶ Press the HELP soft key.
- ▶ Information relevant to the current operation will be displayed.
- ▶ Use the UP/DOWN arrow keys if the explanation is spread over more than one screen page.

To view information on another topic:

- ▶ Press the LIST OF TOPICS soft key.
- ▶ Press the UP/DOWN arrow keys to scroll through the index.
- ▶ Press the ENTER key to select the item you need.

To exit the operating instructions:

- ▶ Press the C key.

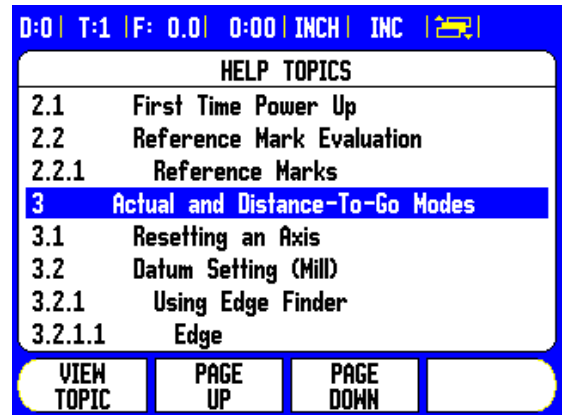

Data Input Forms

Information required for various operational functions and setup parameters are entered through a data input form. These forms will appear after selecting features that require any additional information. Each form provides specific fields for entering the required information.

Changes must be confirmed by pressing the ENTER key for them to become effective. If you do not want to save your changes, press the C key to return to the previous screen without saving changes. In some cases such as the Tool Table, the C key is used in place of the ENTER key.

Instruction Box messages

Whenever a Menu, or Form is opened, an instruction box will also open immediately to the right of it. This message box will provide information for what the chosen function does, and present instructions for available options.

D:1 T:9 F: 0.0 0:00 INCH ABS 			
ERROR COMPENSATION		Error compensation for this input is OFF.	
INPUT 1	0 PPM	Press TYPE to select linear or non-linear error compensation.	
INPUT 2	OFF		
INPUT 3	OFF		
TYPE [OFF]			HELP

Error Messages

If an error occurs while working with the W1000, the message will appear on the display, and provide an explanation of what caused the error. See "Error Messages" on page 119.

To clear the error message:

- ▶ Press the C key.
- Error message will be cleared, and normal operation can be continued.

Power Up



Switch on the power (located on the back). The initial screen will appear. This screen will only appear the very first time the unit is powered up. The following steps may have already been completed by the installer.

- Select the proper language by pressing the LANGUAGE soft key.
- Choose your application of either MILL or TURN. The APPLIC. [MILL/TURN] soft key toggles between these two settings.
- Next, select the number of axes required. When complete, press the ENTER hard key.

If necessary, you can change the application later in Installation Setup under Counter Settings.

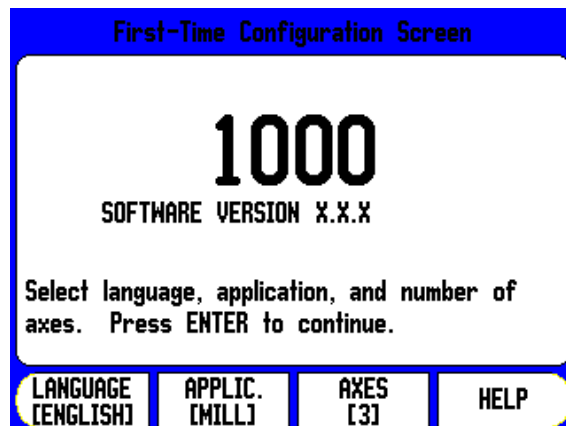

The W1000 is now ready for the remaining setup requirements. It is now in the operating mode “Absolute”. Each active axis will have a flashing “REF” sign next to it. The following section, “Reference Mark Evaluation”, describes setting up this feature.

Reference Mark Evaluation

The W1000 reference mark evaluation feature (1), automatically re-establishes the relationship between axis slide positions and display values that was last defined by setting the datum.

For each axis with an encoder that has reference marks, the “REF” indicator will flash for that axis. After crossing over the reference marks, the indicator will stop flashing and change to a non-flashing “REF” indicator.

Working without reference mark evaluation

The W1000 can also be used without crossing over the reference marks.

- ▶ Press the NO REF soft key to exit the reference mark evaluation routine, and continue.

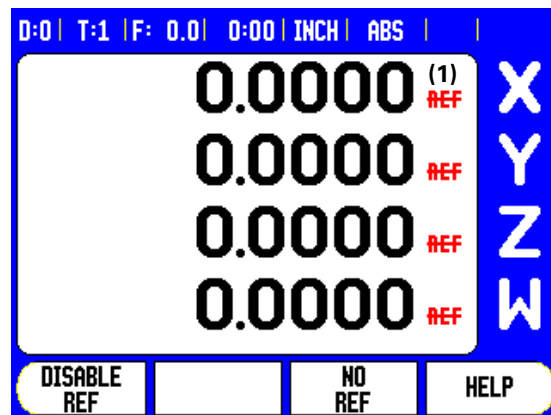

The W1000 can still cross over reference marks at a later time. Such as if it becomes necessary to define a datum that can be re-established after a power interruption.

- ▶ Press the ENABLE REF soft key to activate the position recovery routine. Press the RIGHT / LEFT arrow key if the soft key is not shown on current screen.



If an encoder is setup without reference marks, then the REF indicator will not be displayed, and a datum set from any axis will be lost once power is turned off.

Enable/Disable Ref function

The ENABLE/DISABLE soft key, that is present during the position recovery routine, allows the operator to select a specific reference mark on an encoder. This is important when using encoders with Fixed Reference Marks (instead of ones with Position-Trac™ feature). When the DISABLE REF soft key is pressed, the recovery routine is paused and any reference marks that are crossed during encoder movement are ignored. When the ENABLE REF soft key is then pressed, the recovery routine once again becomes active and the next crossed reference mark will be selected.

Not all reference marks have to be crossed over on each encoder, only those that are needed.

- ▶ Once reference marks for all desired axes are established, press the NO REF soft key to cancel out of the routine. If all reference marks have been found, the W1000 will return to the DRO display screen automatically.

Operating Modes

The W1000 has two operating modes: **Distance-To-Go** (INCREMENTAL), and **Actual Value** (ABSOLUTE). The Actual Value mode always displays the current actual position of the tool, relative to the active datum. In this mode, all moves are done by traveling until the display matches the nominal position that is required. The Distance-To-Go feature enables you to approach nominal positions by traversing to display value zero. When working within the Distance-To-Go mode you can enter nominal coordinates as either absolute or incremental dimensions.

Milling applications have only the tool length offsets active while in the Actual Value Mode. In the Distance-To-Go mode, both the diameter and length offsets are used to calculate the amount of "distance-to-go" required to get to the desired nominal position. This is relative to the edge of the tool that will be doing the cutting.

Turning applications have both diameter and length offsets in both the Actual Value and Distance-To-Go modes.

Press the ABS/INC soft key to toggle between these two modes. To view other soft key functions in either Actual Value or Distance-To-Go mode, use the LEFT/RIGHT arrow keys.

The Milling application provides a quick method for coupling the Z and W axes position on a 4 axis system. For more information, see "Z/W Coupling (4 axes Milling)" on page 50.

The Turning application provides a quick method for coupling the Z axes positions on a 3 axis system. For more information, see "Z Coupling" on page 57.

Setup

W1000 offers two categories for setting up operating parameters. These categories are: Job Setup and Installation Setup. The Job Setup parameters are used to accommodate specific machining requirements for each job. Installation Setup is used to establish encoder, display and communication parameters.

The Job Setup menu is accessed by pressing the SETUP soft key. When in the Job Setup menu, the following soft keys will be available:

- **INSTALLATION SETUP:** Press to begin accessing the Installation Setup parameters. See "Installation Setup Parameters" on page 93..
- **IMPORT/EXPORT:** Press to begin importing or exporting operating parameters. See "Import/Export" on page 19..
- **HELP:** Will open on-line help.

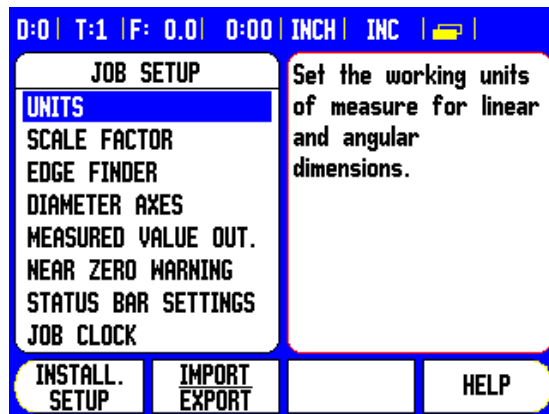

Job Setup Parameters

- ▶ To view and change Job Setup parameters, first press the SETUP soft key. This is the screen that will now be on the DRO.
- ▶ Use the UP/DOWN arrow keys to highlight the parameters of interest.
- ▶ press the ENTER key.

The Installation Setup Data can be imported, or exported using the IMPORT/EXPORT soft key

Exporting the current Job Setup:

- ▶ Press the SETUP soft key.
- ▶ Press the IMPORT/EXPORT soft key.
- ▶ Press the EXPORT soft key.

Importing a new Job Setup Table

- ▶ Press the SETUP soft key.
- ▶ Press the IMPORT/EXPORT soft key.
- ▶ Press the IMPORT soft key.

Units

The Units form is used to specify the preferred display units and format. You can also select the unit of measure by pressing the INCH/MM soft key in either Actual Value or Distance-To-Go mode.

Scale Factor

The scale factor may be used to scale the part up or down. A scale factor of 1.0 creates a part with the exact size as dimensioned on the print. A scale factor >1 "grows" the part, and <1 "shrinks" the part.

- The numeric keys are used to enter a number greater than zero. The number range is 0.1000 to 10.000. A negative value may also be entered.
- The scale factor settings will be retained on a power cycle.
- When the scale factor is a value other than 1, the scaling symbol ∇ is shown on the axis display.
- The ON/OFF soft key is used to disable the current scale factors.

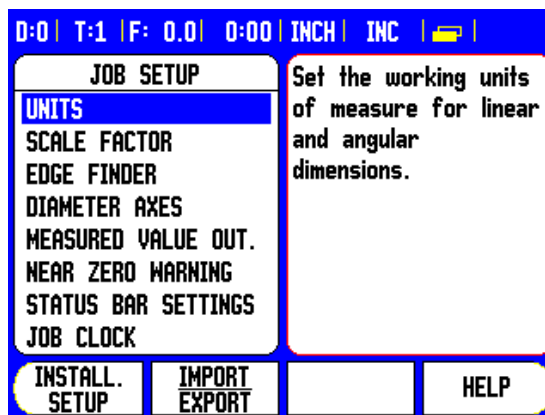

Mirror

A scale factor of -1.00 will produce a mirror image of the part. You can both mirror and scale a part at the same time.

Edge Finder (milling applications only)

The diameter, length offset and units of the edge finder are set in this form. Both values are in the units indicated in the form. Please see "Probing Functions for Datum Setting" on page 28 for details on using Edge Finder functions.

- The numeric keys are used to enter values of diameter and length. The diameter must be greater than zero. The length is a sign value (negative, or positive).
- A soft key is provided to indicate the units of measure for the edge finder.
- The edge finder values will be retained on a power cycle.

Diameter Axes

Select Diameter Axes to bring up the diameter screen shown here to set which axes can be displayed in either radius or diameter values. ON indicates that the axis position will be displayed as a diameter value. When OFF, the Radius/Diameter feature does not apply. For turning applications see "Radius/Diameter Soft Key" on page 56 for the Radius/Diameter feature.

- ▶ Cursor to Diameter Axes, and press ENTER.
- ▶ The cursor will be in the X axis field. Depending on the parameter you need for that axis press ON/OFF soft key to turn feature on or off.
- ▶ Press ENTER.

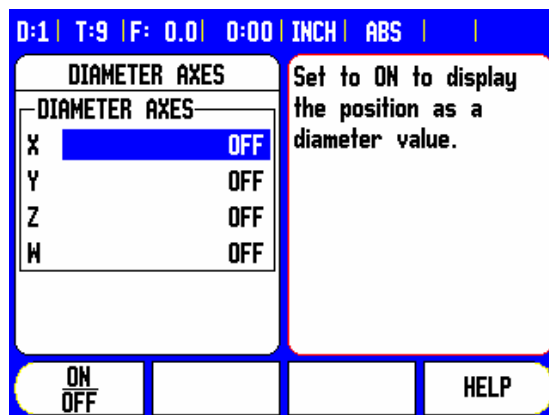

Measured Value Output

With the measured value output feature, probe measurement values can be sent over the serial port. Also output of the current display positions is activated via a command (Ctrl B), sent to the W1000 over the serial port.

The Measured Value Output form is used to set data output during probing operations.

- Data Output Probing (Milling Only), may be set to either On, or Off. When On, the measurement data is output when the probe operation is completed.

Refer to chapter "II - 5 Remote Switch Data Output on page 94" for information on the format of the output data.

Near Zero Warning

The Near Zero Warning form, is used to configure the bar graph. This is shown below the axes' display in Distance-To-Go mode. Each axis has its own range.

- ▶ Press the ON/OFF soft key to enable, or begin entering values using the numeric keys. The current position box will begin moving when the position is within range.

Status Bar Settings

The Status Bar is the segmented bar at the top of the screen which displays current datum, tool, feed rate, job clock and page indicator.

- ▶ Press the ON/OFF soft key for each setting you want to see displayed.

Job Clock

The job clock shows the hours (h), minutes (m), seconds (s). It operates like a stop watch showing elapsed time. The clock starts timing from 0:00:00.

- The elapsed time field shows the total accumulated time from each interval.
- ▶ Press the START/STOP soft key, the status field will read RUNNING. Press it again to stop time from elapsing.

- ▶ Press RESET to reset the elapsed time. Resetting will stop the clock if it is running.



Pressing the Decimal key while in operating mode, will also stop and start the clock. Pressing the Zero key will reset the clock.

Skew Compensation (Milling applications only)

Skew compensation allows the user to drill holes on a workpiece without aligning the workpiece on the machine. Use this feature only for drilling holes.



The Skew Compensation setup form is found under Job Setup. The form is used to turn skew compensation on, or off; to set, or learn the skew angle; and to set the datum.

- ▶ In the Status Field, press the ON/OFF soft key, turn skew compensation on, or off.
- ▶ In the Angle Field, enter the skew angle if known. To learn the angle, use the edge finder (or a tool) to touch off the part.



The skew angle is learned by touching off two points along one side. When using the edge finder, the location of the edge is captured automatically.

- ▶ When using a tool, touch the tool to the edge of the part, and press the TEACH soft key.

Setting the datum

- After learning the angle, the datum may be set to the corner of the part by touching off one point along the other side see "Datum Soft Key" on page 28. In the datum calculation, the system compensates for the radius of the edge finder (or current tool).

The readout automatically compensates for the misaligned workpiece on the machine when running a program, a hole pattern, or preset. Move the machine until the X axis and the Y axis indicate zero.



When skew compensation is activated, the skew icon is displayed on the right side of the axis display.

Remote Switch

The remote switch sets the parameters so the external switch (pendant, or foot switch) can be enabled to perform any or all of the following functions: Data Output; Zero, and Next Hole. Refer to Section II for information on connecting remote switches via Grounding Edge Finder input.

- Data Output - to send position information out of the serial port or to print the current position.
- Zero - to zero one or more axes. In Distance-To-Go mode, it will zero the Distance-To-Go display. In Actual Value mode, it will zero the datum).
- Next Hole key press will move to the next hole within a pattern (i.e. Hole Pattern).
 - ▶ While in the Data Output Field, press the ON/OFF soft key to ON to send the current position over the serial port when the switch is closed.
 - ▶ While in the Zero Field, press the appropriate axis keys to enable or disable zeroing of the axis display positions when the switch is closed.
 - ▶ While in the Next Hole Field, press the ON/OFF soft key to ON to move to the next hole within a pattern.

DRO View Settings

The W1000 has the ability to define up to two DRO display configurations (views). Each view defines which axes displays appear on the screen when the view is selected.

With two views available, one may be set to all available axes, and the other may be a subset of the axes.

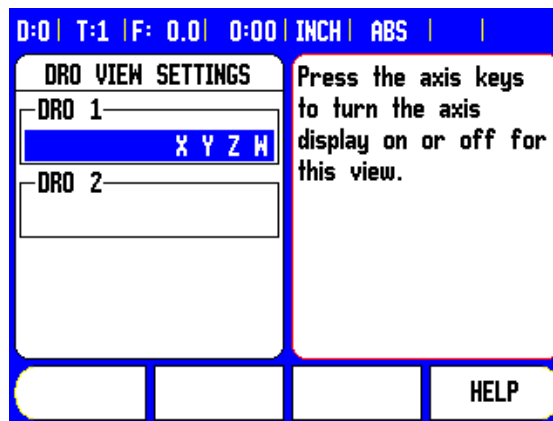

When two DRO views are configured, the DRO mode includes a VIEW soft key which is used to toggle between DRO 1 and DRO 2 views. The current view (1 or 2) is indicated on the soft key.

To setup the DRO views, press SETUP, cursor to DRO view settings, and press ENTER. The configuration form will open.

Press the axis key to turn that axis display on. If an axis key is pressed on an axis that is already on, it will turn off. The default configuration is that all available axes are on for DRO 1, and all axes are off for DRO 2. The W1000 requires that at least one axis must be turned on at all times. Axis view settings are remembered when power is cycled.



Multiple DRO views are only available when the full screen DRO is displayed. In screens where the small DRO is displayed, all axes positions are displayed and multiple DRO views are not available.

When running a program or a single cycle pattern, the large DRO uses the current DRO view that is selected. The view with the graphic and small DRO will show all available axes.



The size of the position values, and the axis labels are adjusted based on the number of axes being displayed. Smallest at 4 axes, largest at 1, or 2 axis display.

Axis keys correspond to the axes being displayed in the current DRO view. If only two axes are being displayed, and there are more axis keys (3 or 4), then only the top two keys will function. Unmatched keys are ignored.

Console Adjustment

The LCD's brightness and contrast can be adjusted either by using the soft keys in this form, or by using the UP/DOWN arrow keys on the keypad in either operating mode. The settings of brightness, and contrast may need to be adjusted due to variations in ambient lighting, and operator preference. This form is also used to set the display saver's idle time-out. The display saver setting is the amount of time the system is idle before the LCD is turned off. The idle time may be set from 30 to 120 minutes. The display saver can be disabled during the current power cycle.

Language

The W1000 supports multiple languages. To change the language selection:

- ▶ Press the LANGUAGE soft key until the desired language selection appears on the soft key, and the form.
- ▶ Press ENTER to confirm your selection.

Import/Export

Job, and Installation Setup parameters can be imported or exported using the serial port. See "Data Interface" on page 89.

- ▶ Press the IMPORT/EXPORT soft key in the Setup screen.
- ▶ Press IMPORT to download operating parameters from a PC.
- ▶ Press EXPORT to upload the current operating parameters to a PC.
- ▶ Press the C key to exit.

Set/Zero Soft Key Details

The SET/ZERO soft key is a key that determines the effect of pressing an Axis key. This key is a toggle key, switching the functionality between Set, and Zero. The current state is indicated in the Status Bar shown as "SET" in this view.

When the state is Set, and the W1000 is in Actual Value mode, selecting an Axis key opens the Datum form for the selected axis. If the W1000 is in Distance-To-Go mode, a Preset form opens.

When the state is Zero, and the W1000 is in Actual Value mode, selecting an Axis key sets the current datum for that axis to zero, at the current position. If it is in Distance-To-Go mode, the current Distance-To-Go value is set to zero.

 If the W1000 is in Actual Value mode and the state of Set/Zero is zero, pressing any Axis key resets the current datum to zero at the current location for that axis.

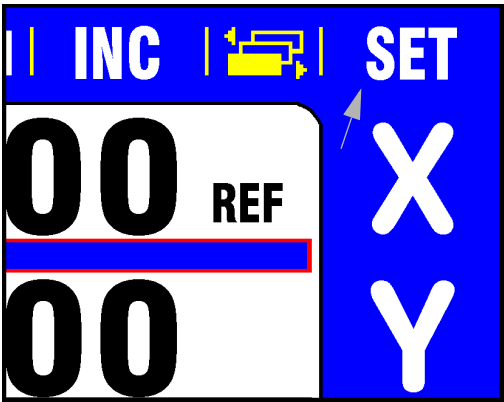

Calc Soft Key

W1000's calculator is capable of handling everything from simple arithmetic to complex trigonometry and RPM calculations.

Press the CALC soft key to access the STANDARD/TRIG and RPM soft keys. The CALC soft key is also available on input forms where performing calculations may be required while inputting data.

 When you need to enter more than one calculation into a numeric field, the calculator will perform multiplication and division before it performs addition and subtraction. If you were to enter $3 + 1 \div 8$, W1000 will divide one by eight, then add three for an answer of 3.125.

Trig functions contain all trig operators as well as, square and square root. Whenever you're calculating the SIN, COS or TAN of an angle, enter the angle first and then press the appropriate soft key.

 Angle values use the current angle format selection of decimal degrees, DMS, or radians.

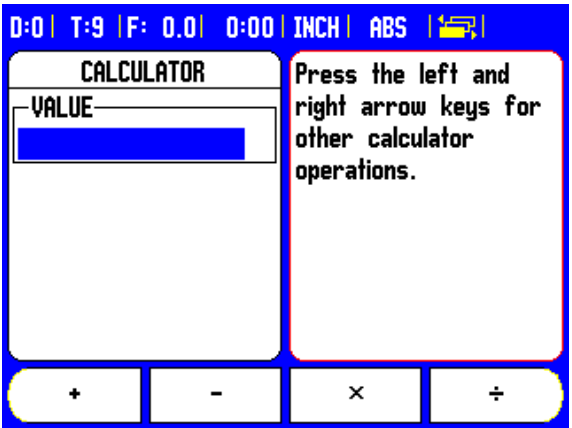

RPM Calculator

The RPM calculator is used to determine the RPM (or surface cutting speed) based on a specified tool (part, for turning applications) diameter. The values shown in this Figure are only an example. Consult your tool manufacturer's manual to verify spindle speed ranges per tool.

- ▶ Press CALC.
- ▶ Press the RPM soft key to open the RPM Calculator form.
- ▶ The RPM calculator requires a tool diameter. Use the numeric hard keys to enter a diameter value. The diameter value will default to the current tool's diameter. If there is no last value entered in this power cycle, the default value is 0.
- ▶ If a surface speed value is required, enter the value using the numeric hard keys. When a surface speed value is entered, the associated RPM value will be calculated.

When in the Surface Speed field, a soft key is available for opening on-line help. The table may be consulted for a recommended range of surface speeds for the material being machined.

- ▶ Press the UNITS soft key to show the units as inch or millimeter.
- ▶ The RPM Calculator form is closed by pressing the C key saving current data.

D:0 T:9 F: 0.0 0:00 INCH ABS			
RPM CALCULATOR			
DIAMETER			
2.0000 INCH			
SURFACE SPEED			
0.0000 FT/MIN			
SPINDLE SPEED			
0.0 RPM			
UNITS		HELP	

Enter the diameter of the rotating tool or part. The spindle speed will be calculated.

I - 3 Milling Specific Operations

This section discusses operations and soft key functions specific to milling applications only.

Soft Key Functions Detailed

Tool Soft Key

This soft key opens the tool table and provides access to the Tool form for entering a tool's parameters (a soft key is used on a one axis readout). The W1000 can store up to 99 tools within the tool table.

Tool Table

The W1000 tool table provides a convenient way to store diameter and length offset information for each of the tools that may be commonly used, up to 99 tools. An example of the Tool Table screen is shown here.

The following soft keys are also available while in the Tool Table form or in the individual tool data form:

D:0 T:1 F: 0.0 0:00 INCH INC			
TOOL TABLE (DIA/LEN/UNITS/TYPE/DIR)			
1	2.000/	20.000 MM	ENGRAVE N
2	5.000/	14.000 MM	PILOT DRILL N
3	25.000/	50.000 MM	CTR-BORE N
4	6.000/	12.000 MM	CARB ML N
5	10.000/	25.000 MM	BROACH N
6	2.000/	0.000 MM	FL END ML N
7			
8	3.000/	5.000 MM	N
TOOL AXIS [Z]	CLEAR TOOL	USE TOOL	HELP

Function	Soft key
Use this key to select which axis all the tool length offsets will affect. The tool's diameter values will subsequently be used to offset the remaining two axes.	
Press to automatically enter the tool offset length. This key is only available in the TOOL LENGTH field.	
The Tool Types form is opened using this key, and is only available in the Type field.	
To remove a tool from the table, use the CLEAR TOOL key.	
To use a tool from the table, highlight the tool, and press the USE TOOL key.	
Press access available help files.	

Import/Export

Tool Table information can be imported, or exported over the serial port.

- ▶ IMPORT, and EXPORT soft keys are available in the Tool Table screen.
- ▶ Press IMPORT to download a Tool Table from a PC.
- ▶ Press EXPORT to upload the Tool Table to a PC.
- ▶ To exit, press the C key.

D:0 T:1 F: 0.0 0:00 INCH INC 				
TOOL TABLE (DIA/LEN/UNITS/TYPE/DIR)				
1	2.000/	20.000	MM	ENGRAVE N
2	5.000/	14.000	MM	PILOT DRL N
3	25.000/	50.000	MM	CTR-BORE N
4	6.000/	12.000	MM	CARB ML N
5	10.000/	25.000	MM	BROACH N
6	2.000/	0.000	MM	FL END ML N
7				
8	3.000/	5.000	MM	N

IMPORT	EXPORT		HELP
--------	--------	--	------

Tool Radius Compensation feature

This allows you to enter workpiece dimensions directly from the drawing. **R** represents the tool radius, and examples of the **R** values are shown in this figure. The displayed distance to go is then automatically lengthened **R+**, or shortened **R-** by the value of the tool radius. For more information see "Presets" on page 33.

The length offset may be entered as a known value or the W1000 may determine the offset automatically. The tool length is the difference in length ΔL between the tool and the reference tool. The length difference is indicated with the " Δ " symbol. The reference tool is indicated by T1.

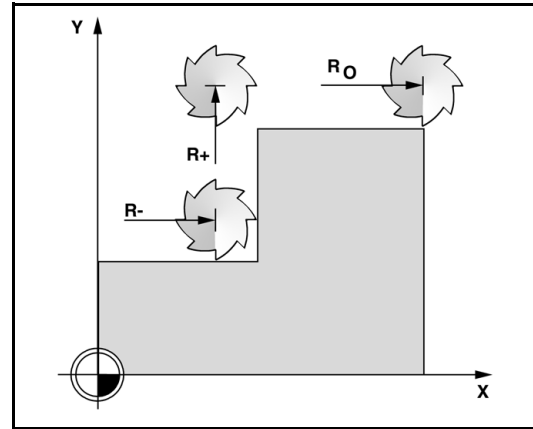

Sign for the length difference ΔL

If the tool is **longer** than the reference tool: $\Delta L > 0 (+)$.

If the tool is **shorter** than the reference tool: $\Delta L < 0 (-)$.

The length offset may be entered as a known value, or the W1000 may determine the offset automatically. To have the W1000 determine a tool's length offset involves touching the tip of each tool to a common reference surface. This allows the W1000 to determine the difference between the length of each tool.

Move the tool until its tip is touching the reference surface. Press the TEACH LENGTH soft key. The W1000 will calculate an offset relative to this surface. Repeat the procedure for each additional tool using the same reference surface.

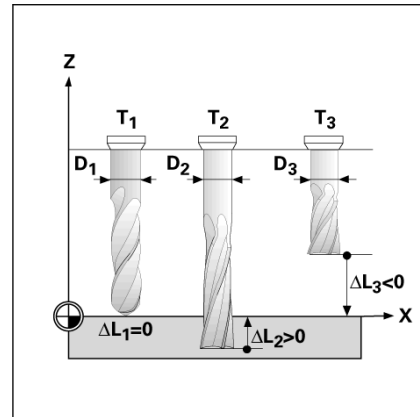

Only the tools set using the same reference surface may be changed without having to reset the datum.

Entering tool data

- ▶ Choose TOOL soft key.
- ▶ Cursor to the desired tool and press ENTER. The Tool Description form will appear.
- ▶ Enter the tool diameter.
- ▶ Enter the tool length or press TEACH LENGTH.
- ▶ Enter the tool units (inch/mm).
- ▶ Enter the tool type.
- ▶ Spindle data is not required unless the Spindle Speed Control has been installed. If installed, then refer to the CSS 1/0 User's Manual.
- ▶ Press C to return to the tool table. Press C to exit.

D:0 T:1 F: 0.0 0:00 INCH INC				
TOOL TABLE (DIA/LEN/UNITS/TYPE/DIR)				
1	2.000/	20.000	MM	ENGRAVE N
2	5.000/	14.000	MM	PILOT DRL N
3	25.000/	50.000	MM	CTR-BORE N
4	6.000/	12.000	MM	CARB ML N
5	10.000/	25.000	MM	BROACH N
6	2.000/	0.000	MM	FL END ML N
7				
8	3.000/	5.000	MM	N

TOOL AXIS [Z]	CLEAR TOOL	USE TOOL	HELP
---------------	------------	----------	------

Tool Table Usage

Example: Entering the tool length and diameter into the tool table.

Tool diameter 2.00

Tool length: 20.000

Tool unit: mm

Tool type: flat end mill



It is also possible to have W1000 determine the length of an offset. See - ALTERNATIVE METHOD -.

D:0 T:9 F: 0.0 0:00 INCH INC				
TOOL		X	0.0000	X Y Z W
DIAMETER		Y	0.0000	
2.0000		Z	0.0000	
LENGTH		W	0.0000	
20		Enter the tool length or press TEACH LENGTH.		
UNITS				
INCH				

TEACH LENGTH			HELP
--------------	--	--	------



Spindle Speed Control information is only required when CSS 1/0 option box is installed. Refer to the CSS 1/0 User Manual if this has been installed.

D:0 T:9 F: 0.0 0:00 INCH INC				
TOOL		X	0.0000	X Y Z W
TYPE		Y	0.0000	
FLAT END MILL		Z	0.0000	
SPINDLE		W	0.0000	
DIRECTION OFF		Press TOOL TYPES to select the tool type.		
SPEED 0				

TOOL TYPES			HELP
------------	--	--	------

Entering a tool:

- ▶ Press the TOOL. soft key. The cursor will default to the Tool Table form.
- ▶ Cursor to the tool you want to define or enter the tool number. Press ENTER.
- ▶ Enter the tool diameter, for example (2).
- ▶ Press the DOWN ARROW key.
- ▶ Enter the tool length, for example, (20).
- ▶ Press the DOWN ARROW key.

-ALTERNATIVE METHOD -

It is also possible to have W1000 determine an offset. This method involves touching the tip of each tool to a common reference surface. This allows W1000 to determine the difference between the length of each tool.

- ▶ Move the tool until its tip is touching the reference surface.
- ▶ Press the TEACH LENGTH soft key. W1000 will calculate an offset relative to this surface.
- ▶ Repeat the procedure for each additional tool using the same reference surface.
- ▶ Press ENTER.

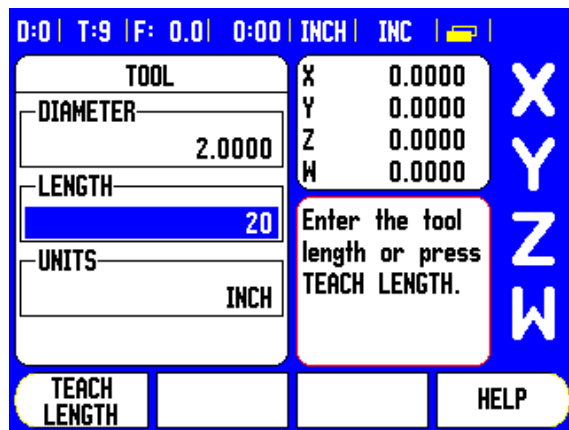



Only the tools set using the same reference surface may be changed without having to reset the datum.



If the tool table already contains tools in which the length has been set, the reference surface should first be established using one of them. If not, you will not be able to switch between the new tools and the existing tools without having to re-establish the datum. Before adding the new tools, select one of the tools from the tool table. Touch the tool to a reference surface and set the datum to 0

TOOL UNIT

- ▶ Enter the tool unit (inch/mm).
- ▶ Cursor to the Tool Type field.

TOOL TYPE

- ▶ Press TOOL TYPES soft key.
- ▶ Press ENTER.

Calling the Tool from the Tool Table

Before you start machining, select the tool you are using from the tool table. W1000 then takes into account the stored tool data when working with tool compensation.

Tool call

- ▶ To call a tool, press the TOOL soft key.
- ▶ Use the UP/DOWN arrow keys to cursor through the selection of tools (1-99). Highlight the tool you want.
- ▶ Verify the proper tool has been called, and press the TOOL, or C key to exit.

Datum Soft Key

Datum settings define the relationships between the axis positions, and the display values.

Setting datum points is done by using the W1000 probing functions either with a tool, or with an edge finder.

Probing Functions for Datum Setting

An electronic Edge Finder can be connected through the edge finder input. The W1000 also supports a grounding type edge finder connected via the 3.5mm Phono Jack on the back of the unit. Both types of edge finders operate the same way.

The following probing soft key functions are available:

- Workpiece edge as datum: EDGE soft key.
- Centerline between two workpiece edges: CENTER LINE soft key.
- Center of a hole or cylinder: CIRCLE CENTER soft key.

In all probing functions, W1000 takes into account the probe's entered tip diameter. During probing functions, with an electronic, or grounding edge finder, the display freezes with the location of the edge, centerline, or circle center.

- ▶ To abort the probing function while it is active, press the C key.



To perform probing, the probe's dimensional characteristics must first be entered into Job Setup. See "Job Setup Parameters" on page 13..

Example: Set centerline between two workpiece edges as datum

0 is offered as a default value for the coordinate. Enter the desired coordinate for the workpiece edge. For this example $Y = 0.0$, set the coordinate as a datum for this workpiece.

► Press the ENTER hard key.

The position of the centerline **M** is determined by probing the edges **1**, and **2**.

The centerline is parallel to the Y axis.

Desired coordinate of the centerline: $X = 0.0$



Spacing between edges is displayed on the message box when using the probe centerline feature.

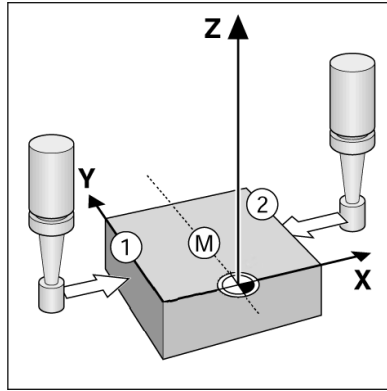

- ▶ Press the DATUM soft key.
- ▶ Press the DOWN arrow key to select the item you need.
- ▶ Press the PROBE soft key.

Probe the 1st edge **X**

- ▶ Move the edge finder toward workpiece edge **1** until the LEDs in the edge finder light up.

Probe the 2nd edge in **X**

- ▶ Move the edge finder toward workpiece edge **2** until the LEDs in the edge finder light up. The distance between the edges is displayed on the message box.
- ▶ Retract the edge finder from the workpiece.

Enter the value for **X**

- ▶ Enter coordinate (X = 0.0), and transfer coordinate as datum for the centerline.
- ▶ Press the ENTER hard key.

Example: Probe the center of a hole with an edge finder, and set the datum 2.00 from the circle's center

X coordinate of the circle center: X = 2.00

Y coordinate of the circle center: Y = 2.00

- ▶ Press the DATUM soft key.
- ▶ Press the DOWN arrow key to select the item you need.
- ▶ Press the PROBE soft key.
- ▶ Press the CIRCLE CENTER soft key.
- ▶ Move the edge finder toward the first point **1** on the circumference until the LEDs in the edge finder light up.
- ▶ Probe two additional points on the circumference in the same manner. Further instructions appear on the screen. See Instruction Box for the measured diameter.

Enter center point **X** X = 2.00

- ▶ Enter the first coordinate (X = 2.00).
- ▶ Press the DOWN arrow hard key.

Enter center point **Y** Y = 0.00

- ▶ Accept default entry Y = 2.00.
- ▶ Press the ENTER hard key.

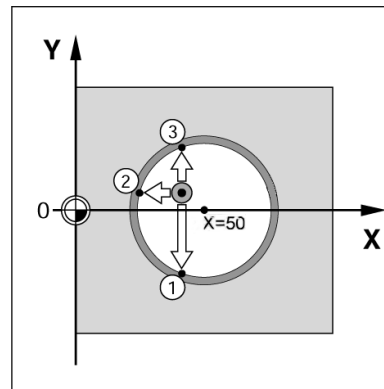

Probing with a Tool

If using a tool, or non-electrical edge finder to set datum points, the W1000 probing functions can still be used.

Datum points can be set by touching the edges of a workpiece, one after the other with a tool, and then manually entering the tool's position as datum points.

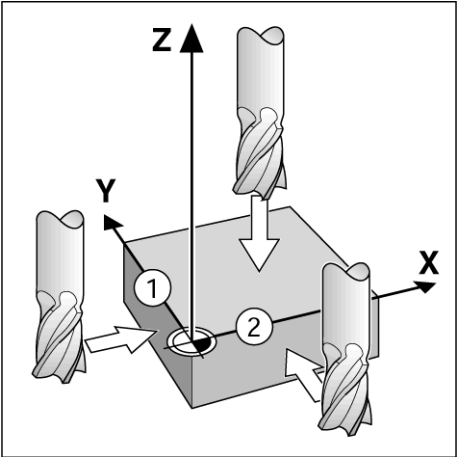

D:1 T:9 F: 0.0 0:00		INCH	ABS	SET
SET DATUM		X	0.0000	X Y Z W
DATUM NUMBER		Y	0.0000	
1		Z	0.0000	
DATUM		W	0.0000	
X	-1.5000	Enter the new actual position of the tool or press PROBE.		
Y	-1.5000			
Z	0			
W				
PROBE		CALC		HELP

Example: Probe workpiece edge and set edge as datum

- ▶ Preparation: Set the active tool to the tool that will be used to set the datum. An end mill is shown in this example, along with the Set Datum screen.
 - Datum axis: X = 0
 - Tool diameter D = 0.25"
- ▶ Press DATUM.
- ▶ Press the Down arrow key until the X axis field is highlighted.
- ▶ Press PROBE soft key.
- ▶ Press EDGE soft key.
- ▶ Touch workpiece edge.
- ▶ Press the TEACH soft key to store the current absolute value while the tool is in contact with the workpiece edge. The location for the touched edge will take into account the diameter of the tool in use (T:1, 2...), and the last direction the tool was moved prior to pressing the TEACH soft key.
- ▶ Retract the tool from the workpiece and enter 0" and then press ENTER.

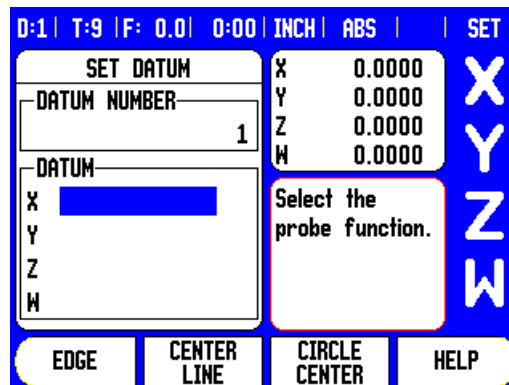
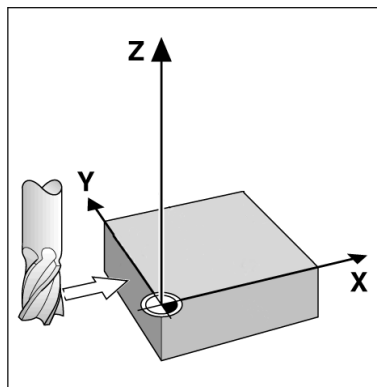

Presets

The Preset function allows the operator to indicate the nominal (target) position for the next move. Once the new nominal position information is entered the display will switch to Distance-To-Go mode and show the distance between the current position and the nominal position. The operator now only needs to move the table until the display is zero and he will be at the required nominal position. The information for the location of the nominal position can be entered as an absolute move from the current datum zero or as an incremental move from the current nominal position.

Presetting also allows the operator to indicate which side of the tool will be doing the machining at the nominal position. The R+/- soft key in the Preset form defines the offset that will be in effect during the move. **R+** indicates that the center line of the current tool is in a more positive direction than the edge of the tool. **R-** indicates that the center line is in a more negative direction than the edge of the current tool. Using R+/- offsets automatically adjusts the distance-to-go value to account for the diameter of the tool.

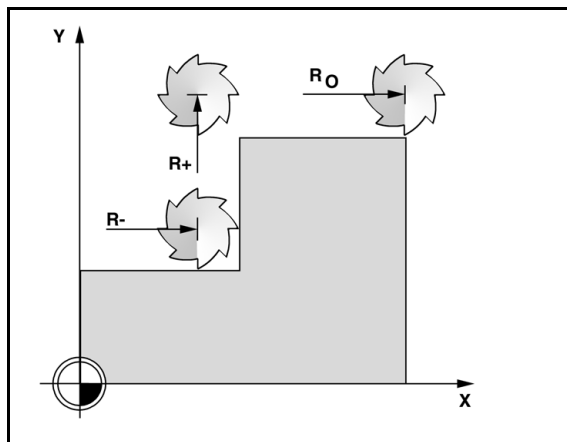

Absolute Distance Preset

Example: Milling a shoulder by traversing to display value zero using absolute position.

The coordinates are entered as absolute dimensions; the datum is the workpiece zero. Using this figure example:

- Corner 1: X = 0 / Y = 1
- Corner 2: X = 1.50 / Y = 1
- Corner 3: X = 1.50 / Y = 2.50
- Corner 4: X = 3.00 / Y = 2.50



Press the PRESET soft key, then an axis key to recall the last entered preset value for that axis.

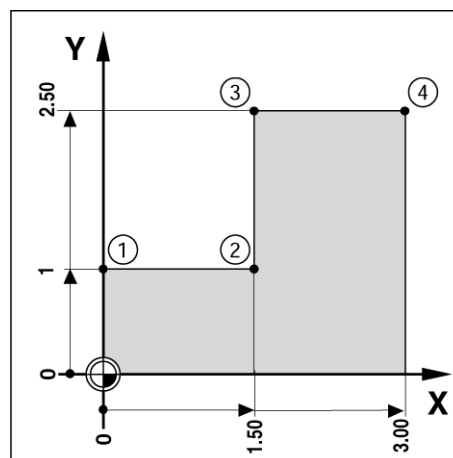

Preparation:

- ▶ Select the tool with the appropriate tool data.
- ▶ Pre-position the tool to an appropriate location (such as X = Y = -1").
- ▶ Move the tool to milling depth.
- ▶ Press the PRESET soft key.
- ▶ Press the Y axis key

-ALTERNATIVE METHOD -

- ▶ Press the SET/ZERO soft key so that you are in Set mode.
- ▶ Press the Y axis key.
- ▶ Enter nominal position value for corner point **1**: Y = 1", and select tool radius compensation R + with R+/- soft key. Press until R+ is shown next to axis form.
- ▶ Press ENTER.
- ▶ Traverse the Y axis until the display value is zero. The square in the near zero warning is now centered between the two triangular marks.
- ▶ Press the PRESET soft key.
- ▶ Press the X axis key.

-ALTERNATIVE METHOD -

- ▶ Press the SET/ZERO soft key so that you are in Set mode.
- ▶ Press the X axis key.
- ▶ Enter nominal position value for corner point **2**: X = 1.5" select tool radius compensation R - with R+/- soft key. Press twice until R- is shown next to axis form.
- ▶ Press ENTER.
- ▶ Traverse the X axis until the display value is zero. The square in the near zero warning is now centered between the two triangular marks.
- ▶ Presets can be entered in the same manner for corners 3, and 4.

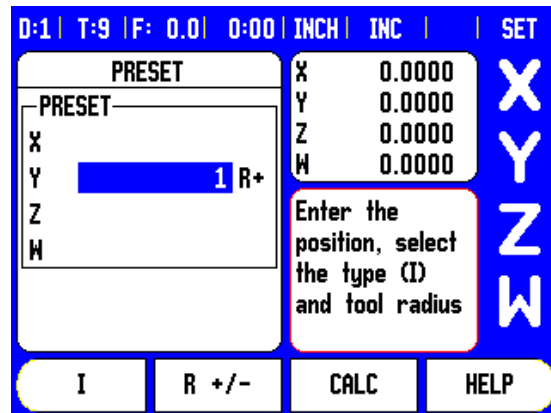

Incremental Distance Preset

Example: Drilling by traversing to display value zero with incremental positioning.



Enter the coordinates in incremental dimensions. These are indicated in the following (and on the screen) with a preceding **I** (Incremental). The datum is the workpiece zero.

- Hole **1** at: X = 1" / Y = 1"
- Distance from hole **1** to hole **2**: XI = 1.5" / YI = 1.5"
- Hole depth: Z = -0.5"
- Operating mode: DISTANCE-TO-GO (INC)
- ▶ Press the PRESET soft key.
- ▶ Press the X axis key.
- ▶ Enter nominal position value for hole **1**: X = 1" and ensure no tool radius is active. Note that these presets are Absolute Presets.
- ▶ Press the DOWN arrow key.
- ▶ Enter nominal position value for hole 1: Y = 1".
- ▶ Ensure no tool radius compensation is showing.
- ▶ Press the DOWN arrow key.
- ▶ Enter the nominal position value for the hole depth: Z = -0.5". Press ENTER hard key.
- ▶ Drill hole 1: Traverse the X, Y and Z axis until the display value is zero. The square in the near zero warning is now centered between the two triangular marks. Retract the drill.

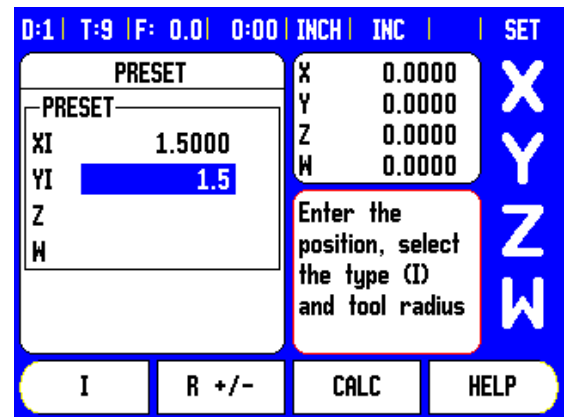
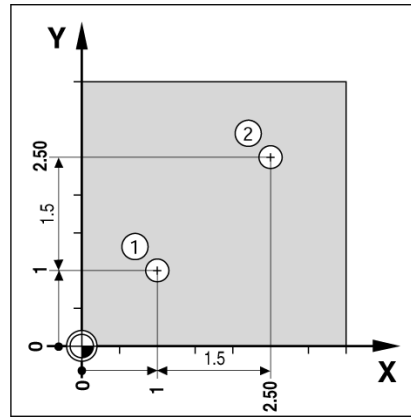

To preset the location for Hole 2:

- ▶ Press the PRESET soft key.
- ▶ Press the X axis key.
- ▶ Enter nominal position value for hole **2**: X = 1.5", mark your input as an incremental dimension, press the I soft key.
- ▶ Press the Y axis key.
- ▶ Enter nominal position value for hole **2**: Y = 1.5", mark your input as an incremental dimension, press the I soft key.
- ▶ Press ENTER.
- ▶ Traverse the X and Y axes until the display value is zero. The square in the near zero warning is now centered between the two triangular marks.
- ▶ To preset the Z axis:
 - ▶ Press the PRESET soft key.
 - ▶ Press the Z axis key.
 - ▶ Press the ENTER key (use last entered preset).
- ▶ Drill hole 2: Traverse Z axis until the display value is zero. The square in the near zero warning is now centered between the two triangular marks.
- ▶ Retract the drill.

1/2 Soft Key

The 1/2 hard key is used to find the centerline (or midpoint) between two locations along a selected axis of a workpiece. This can be performed in either Actual Value or Distance-To-Go mode.







This feature will change datum locations when in Actual Value mode.

Features (Milling)

Pressing the FEATURES soft key will provide access to the Circle Pattern, Linear Pattern, Incline Mill, and Arc Mill milling features.

The W1000 provides one user definable pattern each of these features. They can be recalled, and executed from the DRO anytime during operation.

The following soft keys are available while in the Milling Feature table.

Function	Soft key
Press to access the circle pattern table.	
Press to access the linear pattern table.	
Press to access the Incline Mill entry form.	
Press to access the Arc Mill entry form.	

The Circle Pattern, and Linear Pattern features provide ways to calculate, and machine various hole patterns. The Incline, and Arc milling features provide ways to machine a flat diagonal surface (incline milling), or a rounded surface (arc milling) using a manual machine.



Defined Circle, Linear, Incline, and Arc patterns are remembered when power is cycled

Circle, and Linear Patterns









This section describes the Circle, and Linear pattern tables, and capabilities. The W1000 provides storage of 10 user definable patterns each for Circle, and Linear. Once patterns are defined, they are remembered when power is cycled. They can be recalled, and executed from the DRO, or from a program.

The View Graphic enables verification of the hole pattern before you start machining. It is also useful when selecting holes directly, executing holes separately, and skipping holes.

To access the Circle Pattern Table, or Linear Pattern Table, press the **FEATURES** soft key. The **CIRCLE PATTERN**, and **LINEAR PATTERN** soft keys are shown. Pressing one of these soft keys will open the corresponding hole pattern table.

Soft key Functions

The following soft keys are available while in the Circle, and Linear Pattern Milling feature.

Function	Soft key
Press to access the FEATURES soft keys.	
Press to access the circle pattern table.	
Press to access the linear pattern table.	
Press to create a new circle, or linear pattern.	
Press to edit an existing pattern.	
Press CLEAR to delete an existing pattern.	
Press RUN to execute a pattern.	
Press HELP for additional information about the pattern.	

Circle, and Linear Pattern Table Entry

The Circle, or Linear Pattern Table is used to define up to 10 different circle hole patterns (Full, or Segment), and 10 different linear hole patterns (Array, or Frame).

- ▶ Access the Pattern Table from the DRO soft key menu by pressing the FEATURES soft key.
 - The Pattern Table will show all of the patterns that have been previously defined.
- ▶ Press the CIRCLE PATTERN, or LINEAR PATTERN soft key.
 - A Circle, or Linear Pattern form is opened.
- ▶ Press the UP/DOWN arrow keys to define a new pattern, or edit an existing pattern.
- ▶ Highlight the table entry, press the NEW, or EDIT soft key (or press ENTER).
 - A Circle, or Linear Pattern form is opened.
- ▶ Enter the information to define the pattern, then press ENTER.
 - The pattern will be entered into the appropriate table. It can now be modified, executed, or referred to from a program.
- ▶ To delete a pattern from the table press the CLEAR soft key. Press YES to confirm deletion from the table.



The pattern table, and its entries are saved to memory. They will stay in memory until deleted, or changed, and are not affected by a power cycle.

CIRCLE PATTERN TABLE				
1	SEGMENT	4	(2.0000,0.0000)	5.0000 25
2	SEGMENT	3	(1.0000,1.0000)	1.0000 20
3	SEGMENT	8	(10.0000,0.0000)	2.5000
4				
5				
6				
7				
8				

EDIT CLEAR RUN HELP

LINEAR PATTERN				
1	ARRAY	(0.0000,0.0000)	5	1.0000
2	ARRAY	(1.2500,0.0000)	4	1.5000
3				
4				
5				
6				
7				
8				

NEW HELP

Circle, and Linear Pattern Soft keys

The following additional soft keys are available while in the Circle, and Linear Pattern Milling feature.

Function	Soft key
Press to execute the circle or linear pattern.	RUN
Press to use the current absolute position.	TEACH
Press to open the Calculator for standard math, and trigonometry functions.	CALC

Circle Pattern Information Required

- Type: type of pattern, FULL, or SEGMENT.
- Holes: number of holes in the pattern.
- Center: location of the center of the hole pattern.
- Radius: radius of the pattern.
- Start Angle: angle between X axis and the first hole.
- End Angle: angle between X axis and the last hole.
- Depth: the target depth for drilling in the tool axis.

Linear Pattern Information Required



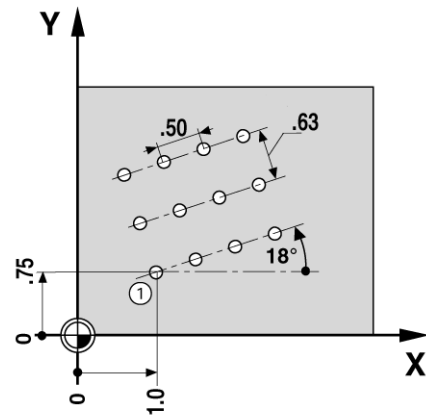

- Type: type of pattern, ARRAY or FRAME.
- First Hole: location of the first hole of the pattern.
- Holes per Row: number of holes in each row of a pattern.
- Angle: the angle, or rotation of the pattern.
- Depth: the target depth for drilling in the tool axis.
- Number of Rows: the number of rows in the pattern.
- Row Spacing: the spacing between each row of the pattern.



Circle, or Linear Pattern Execution

- ▶ To execute a circle, or linear pattern, highlight the pattern to be executed in the table.
- ▶ Press the RUN soft key.
 - The W1000 then calculates the positions of the holes. It can also provide a graphical view of the hole pattern.

The following soft keys are available while running a Circle, or Linear Pattern

Function	Soft key
Press to select the graphic view of the pattern. Available in both incremental DRO, or absolute DRO.	
Press to select the previous hole in the pattern.	
Press to select the next hole in the pattern.	
Press to end execution of the pattern.	



Press the VIEW soft key to toggle the views between distance-to-go positions, graphic view, and absolute positions.

Example: Enter data and execute a circle pattern.

1st step: Enter data

- ▶ Press FEATURES soft key.
- ▶ Press CIRCLE PATTERN soft key.
- ▶ Press UP/DOWN hard keys to select pattern 1.
- ▶ Press ENTER hard key.
- ▶ Press FULL/SEGMENT soft key until FULL is selected.
- ▶ Press DOWN ARROW hard key to move to the next field.
- ▶ Enter 4 for the number of holes.
- ▶ Enter X= 2.0", Y= 1.5" for the circle pattern center location.

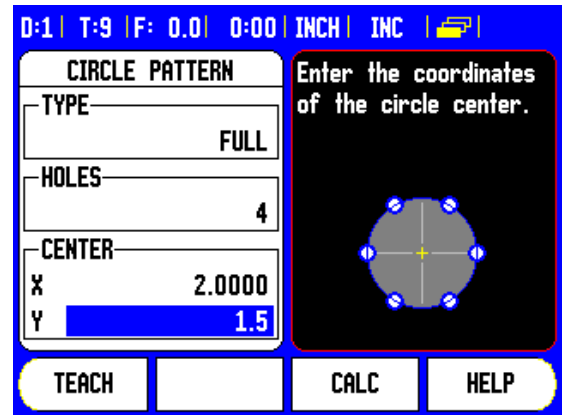

- ▶ Enter 5" for the radius of the circle pattern.
- ▶ Enter 25° for the start angle.
- ▶ The end angle is 295°, and can not be changed because the pattern is full.
- ▶ Enter depth of -.25".
 - The depth of the hole is optional, and may be left blank.
- ▶ Press ENTER

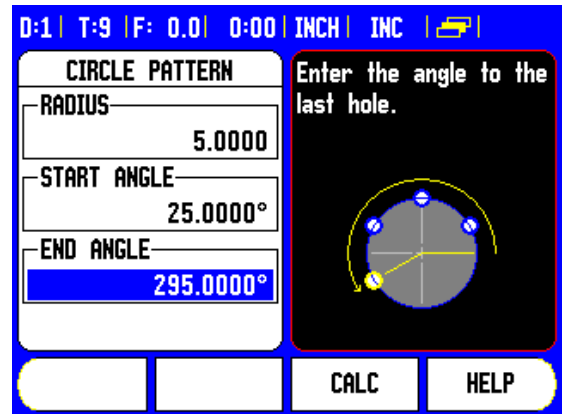

The Circle Pattern table now shows the pattern that was just defined as pattern 1.

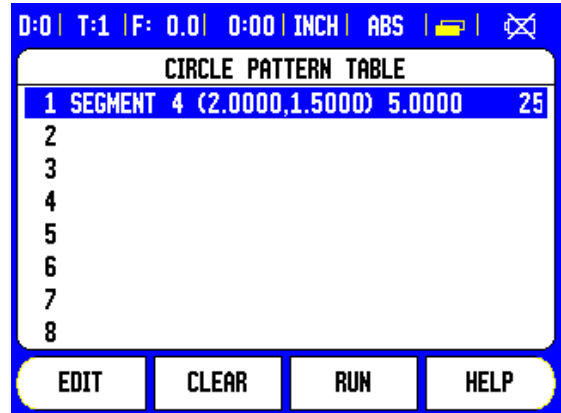

2nd step: Execute circle pattern

- ▶ Press the RUN soft key.
 - The distance-to-go view is displayed.
- ▶ Move to the hole, move the X, and Y axis until their display values show 0.0.
- ▶ Drill (Z depth): If a depth was entered into the pattern, move Z until it's display value shows 0.0. Otherwise, drill to the desired depth.
- ▶ Press the NEXT HOLE soft key.
- ▶ Continue to drill the remaining holes in the same manner.

When the pattern is complete, press the END soft key.

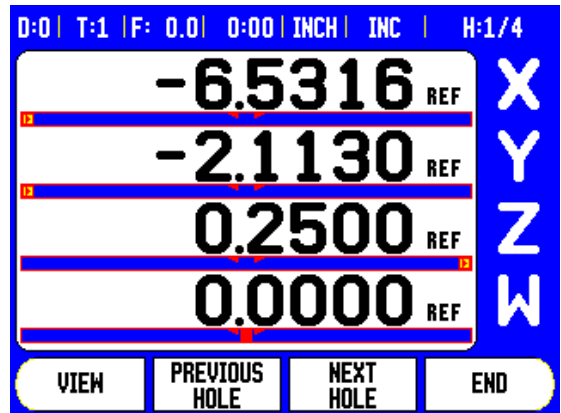

Incline, and Arc Milling







The incline and arc milling features provide ways to machine a flat diagonal surface (incline milling) or a rounded surface (arc milling) using a manual machine.

The W1000 provides storage of up to 10 user definable Incline Mill features, and 10 Arc Mill features. Once the features are defined, they are stored in memory and can be recalled at anytime. They can be executed from the DRO, or from the operating program. All defined features will stay in memory until removed, regardless if the power has been cycled.

To access the Incline or Arc Mill Table, press the FEATURE soft key, then press the INCLINE MILL, or ARC MILL soft key to open the corresponding mill table.

Soft Key Functions

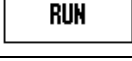
The following soft keys are available while in the Milling Feature table.

Function	Soft key
Press to access the Incline Mill Table.	
Press to access the Arc Mill Table.	
Press to create a new milling feature.	
Press to edit and existing milling feature.	
Press to delete and existing milling feature.	
Press to execute the milling feature.	
Press for additional information about the milling feature.	

Incline, and Arc Milling Table Entry

The Incline or Arc Mill Table is used to define the milling features. To access either Mill Table:

- ▶ Press the FEATURES soft key.
- ▶ Press the INCLINE MILL, or ARC MILL soft key.

To define a new milling feature:

- ▶ Press the UP/DOWN ARROW hard keys to highlight a blank feature.
- ▶ Press the NEW soft key, or press ENTER.

To edit an existing feature:

- ▶ Press the UP/DOWN ARROW hard keys to highlight the table entry.
- ▶ Press the EDIT, soft key, or press ENTER.

To execute a milling feature:

- ▶ Highlight the table entry, and press the RUN soft key.
 - See "Incline, & Arc Mill Execution" for more information.

To delete an existing feature:

- ▶ Highlight the table entry.
- ▶ Press the CLEAR soft key.
- ▶ Press YES to confirm deletion.

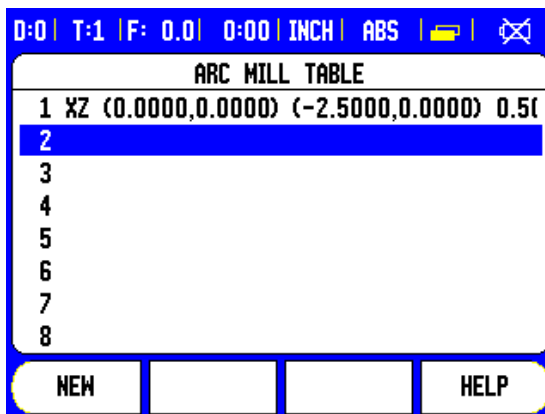
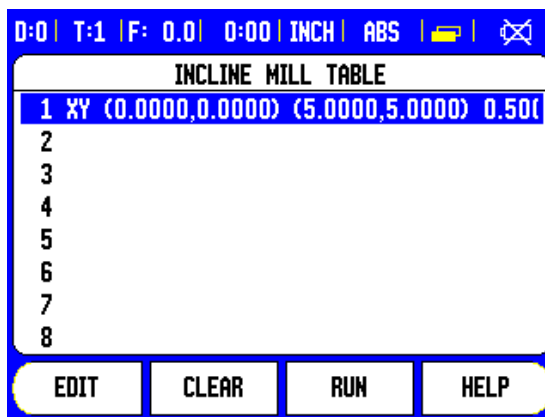

Incline, and Arc Milling Table Entry

The following soft keys are available while in the entry form.

Function	Soft key
Press to select a plane ([XY], [YZ], or [XZ])	PLANE [XY]
Press to execute the milling operation	RUN
Press to use the current absolute position	TEACH
Press to open the Calculator for standard math, and trigonometry functions.	CALC

The Incline Milling form is used to specify the flat surface to be milled. The data is entered through the "Incline Mill Table". Selecting an incline mill entry, and then pressing the NEW, or EDIT soft key, (or ENTER), will allow the feature to be defined. The following listed fields require data input.

- **Plane:** Select the plane by pressing the PLANE soft key. The current selection is shown on the soft key and in the plane field. The graphic in the message box aids in selecting the correct plane.
- **Start Point:** Enter the coordinates of the start point, or press TEACH to set the coordinate to the current position.
- **End Point:** Enter the coordinates of the end point, or press teach to set the coordinate to current position.
- **Step:** Enter the step size. When milling, this is the distance between each pass or each step along the line.



The Step size is optional. If the value is zero, the operator decides at run-time how far to move between each step.

Press the ENTER key to close the form and save the feature to the table. Press the RUN soft key to execute the surface milling operation. Press C hard key to exit the form without saving the feature.



The table, and its entries are saved to memory. They will stay in memory until deleted, or changed, and are not affected by a power cycle.

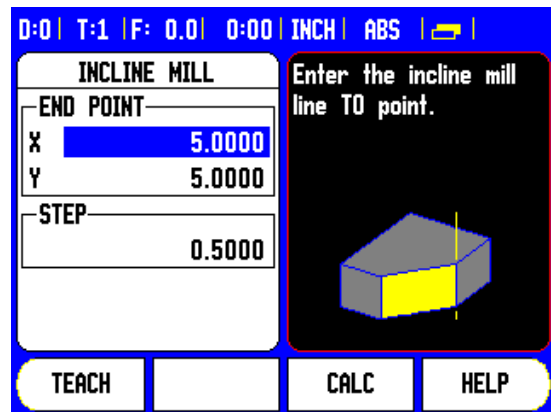

Arc Milling

The Arc Milling form is used to specify the curved surface to be milled. The data is entered through the "Arc Mill Table". Selecting an arc mill entry, and then pressing the NEW, or EDIT soft key, (or ENTER), will allow the feature to be defined.

The following listed fields require data input.

- **Plane Selection:** Select the plane by pressing the PLANE soft key. The current selection is shown on the soft key, and in the plane field. The graphic in the message box aids in selecting the correct plane.
- **Center Point:** Enter the coordinates of the arc's center point, or press TEACH to set the coordinate to the current position.
- **Start Point:** Enter the coordinates of the start point, or press TEACH to set the coordinate to current position.
- **End Point:** Enter the coordinates of the end point, or press TEACH to set the coordinate to current position.
- **Step:** Enter the step size. When milling, this is the distance along the circumference of the arc between each pass, or step along the arc's contour.



The Step size is optional. If the value is zero, the operator decides at run-time how far to move between each step.

MILL ARC	
PLANE	XZ
CENTER POINT	
X	0.0000
Z	0.0000

Press PLANE to select the plane.

PLANE [XZ] HELP

MILL ARC	
START POINT	
X	-2.5000
Z	0.0000
END POINT	
X	0.0000
Z	-2.5000

Enter the incline mill arc FROM point.

TEACH CALC HELP

Press the ENTER key to close the form and save the feature to the table. Press the RUN soft key to execute the surface milling operation. Press C hard key to exit the form without saving the feature.

Incline, and Arc Mill Execution

- ▶ To execute a milling operation, select the feature from the table to open the entry form.
- ▶ Press the RUN soft key.
 - The screen switches to the incremental DRO view, showing the incremental distance from the start point.

The following soft keys are available while running an Incline, or Arc Milling feature.

Function	Soft key
Press to select the incremental DRO, contour view of feature, or absolute DRO	VIEW
Press to return to the previous pass.	PREVIOUS PASS
Press to advance to the next pass.	NEXT PASS
Press to end execution of the milling operation.	END

The tool radius compensation is applied based on the radius of the current tool. If the plane selection involves the tool axis, the tool tip is assumed to have a ball end.

- ▶ Move to the start point and make a plunge cut or the first pass across the surface.
- ▶ Press the NEXT PASS, soft key to continue with the next step along the contour.
 - The incremental display shows the distance from the next pass along the line, or arc's contour.



- ▶ To follow the contour, move the two axes in small steps, keeping the **X**, and **Y** positions as close to zero (0.0) as possible.
 - When no step size is specified, the incremental display always shows the distance from the closest point on the arc.
- ▶ Press the VIEW soft key to toggle through the three available views (incremental DRO, contour, and absolute DRO).
 - The contour view shows the position of the tool relative to the milling surface. When the cross hair representing the tool is on the line representing the surface, the tool is in position. The tool cross hair remains fixed in the center of the graph. As the table is moved, the surface line moves.
- ▶ Press END to exit the milling operation.



The tool offset direction (R+ or R-) is applied based on the tool position. The operator must approach the contour surface from the appropriate direction for tool compensation to be correct.

Z/W Coupling

Z/W Coupling (4 axes Milling)

The W1000 Milling application provides a quick method for coupling the Z and W axes positions on a 4 axis system. The display can be coupled in either the Z or W displays.

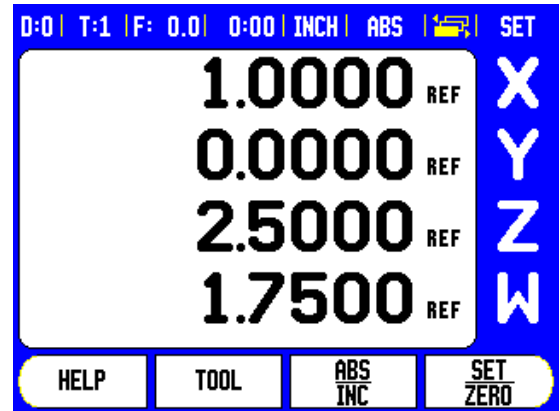

Enabling Z/W Coupling

To couple the Z and W axes and have the result displayed on the Z display, press and hold the Z key approximately 2 seconds. The sum of the Z/W positions will be displayed on the Z display and the W display will be blanked.

To couple the Z and W axes and have the result displayed on the W display, press and hold the W key for approximately 2 seconds. The sum of the Z/W positions will be displayed on the W display and the Z display will be blanked. The coupling is preserved in between power cycles.

Moving either Z or W inputs will update the coupled Z/W position.

When a position is coupled, the reference mark for both encoders must be found in order to recall the previous datum.

Disabling Z/W Coupling

To disable Z/W Coupling, press the axis key of the display that is blank. The individual Z and W display positions will be restored.

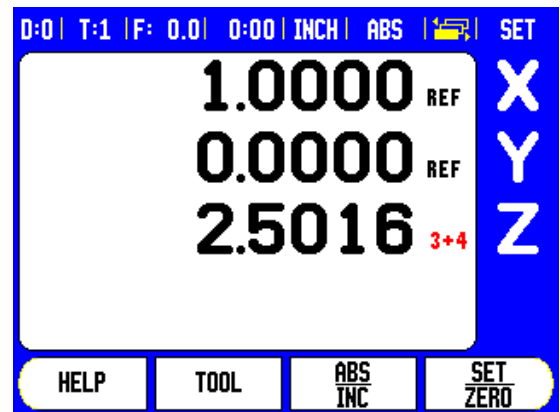

I - 4 Turning Specific Operations

This section discusses operations specific to turning applications only.

Tool Display Icon

The \emptyset icon is used to indicate that the displayed value is a diameter value. No icon visible indicates that the display is a radius value.

Tool Table

The W1000 can store the dimensional offsets for up to 99 tools (see sample screen). When you change a workpiece and establish a new datum, all tools are automatically referenced from the new datum.

TOOL TABLE (X/Z)	
1	-9.5855 \emptyset
2	
3	
4	
5	-8.6555 \emptyset
6	
7	
8	

0:1 | T:1 | F: 0.0 | 0:00 | INCH | ABS |

CLEAR TOOL USE TOOL HELP

Setting Tool Offsets Example 1: Using TOOL/SET

Before you can use a tool, you must enter its offset (the cutting edge position). Tool offsets can be set using the TOOL/SET or LOCK AXIS feature.

The TOOL/SET operation can be used to set a tool's offset using a tool when the diameter of the workpiece is known.

- ▶ Touch the known diameter in the X axis (1).
- ▶ Press the TOOL soft key.
- ▶ Scroll to the desired tool.

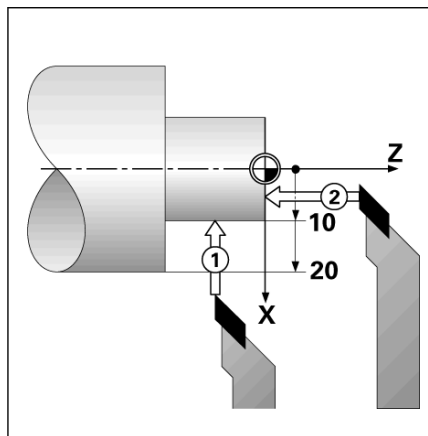

- ▶ Press the ENTER key.
- ▶ Select the axis (X) key.
- ▶ Enter the position of the tool tip, for example, X=.100. Remember to ensure the W1000 is in diameter display mode (Ø) if the input is a diameter value.
- ▶ Touch the workpiece face with the tool.
- ▶ Cursor to the Z axis (2), then set the position display for the tool tip to zero, Z=0.
- ▶ Press ENTER.

Setting Tool Offsets Example 2: Using LOCK AXIS Function

The LOCK AXIS function can be used to set a tool's offset when a tool is under load and the diameter of the workpiece is not known.

The LOCK AXIS function is useful when determining tool data by touching the workpiece. To avoid losing the position value when the tool is retracted to measure the workpiece, this value can be stored by pressing LOCK AXIS.

To use the LOCK AXIS function:

- ▶ Press the TOOL soft key.
- ▶ Select tool and press ENTER.
- ▶ Press the X axis key.
- ▶ Turn a diameter in the X axis.
- ▶ Press the LOCK AXIS soft key while the tool is still cutting.
- ▶ Retract from the current position.
- ▶ Turn the spindle off and measure the workpiece diameter.
- ▶ Enter the measured diameter or radius, and press ENTER. Remember to ensure the W1000 is in diameter display mode Ø if you input a diameter value.

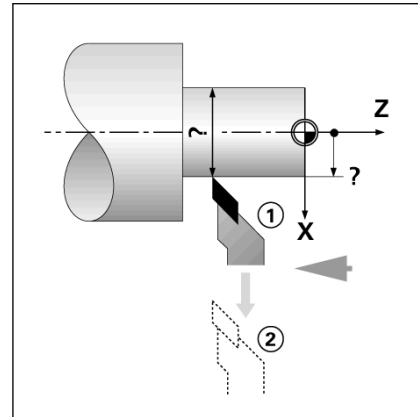

Calling a Tool from the Tool Table

- ▶ To call a tool, press the TOOL soft key.
- ▶ Use the Up/Down arrow keys to cursor through the selection of tools (1-99). Highlight the tool you want.
- ▶ Verify the proper tool has been called, and press either the use TOOL soft key, or the C key to exit.

Datum Setting

See "Datum Soft Key" on page 28. for basic information. Datum settings define the relationships between the axis positions and the display values. For most lathe operations there is only one X-axis datum, the center of the chuck, but it may be helpful to define additional datums for the Z-axis. The table can hold up to 10 datum points. The recommended way to set datum points is to touch a workpiece at a known diameter, or location, then enter that dimension as the value that the display should be showing.

Example: Setting a workpiece datum

Preparation:

- ▶ Call the tool data by selecting the tool which you are using to touch the workpiece.
- ▶ Press the DATUM soft key. The cursor will be in the DATUM NUMBER field.
- ▶ Enter the datum number, and press the DOWN arrow key to go to the X-axis field.
- ▶ Touch the workpiece at point 1.
- ▶ Enter the radius or diameter of the workpiece at that point. Remember to ensure the W1000 is in diameter display mode \emptyset if you input a diameter value.

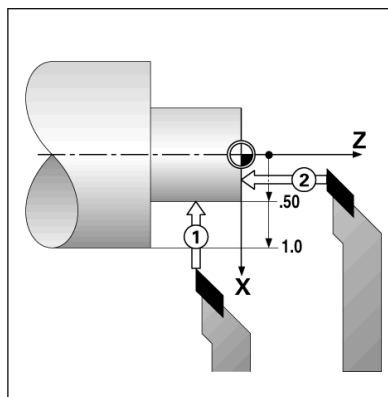
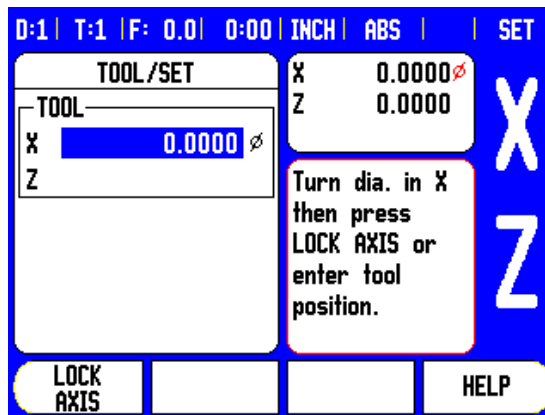

I - 4 Turning Specific Operations

- ▶ Press the DOWN arrow key to advance to the Z axis.
- ▶ Touch the workpiece surface at point 2.
- ▶ Enter the position of the tool tip (Z= 0) for the Z coordinate of the datum.
- ▶ Press ENTER.

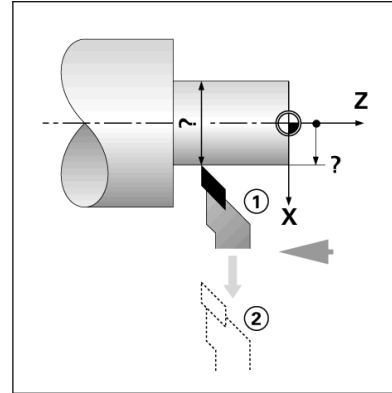

Setting Datums using LOCK AXIS Function

The LOCK AXIS function is useful for setting a datum when a tool is under load and the diameter of the workpiece is not known.

To use the LOCK AXIS function:

- ▶ Press the DATUM soft key. The cursor will be in the DATUM NUMBER field.
- ▶ Enter the datum number and press the DOWN arrow key to go to the X axis field.
- ▶ Turn a diameter in the X axis.
- ▶ Press the LOCK AXIS soft key while the tool is still cutting.
- ▶ Retract from the current position.
- ▶ Turn the spindle off and measure the workpiece diameter.
- ▶ Enter the measured diameter, for example, 1.5" and press ENTER.

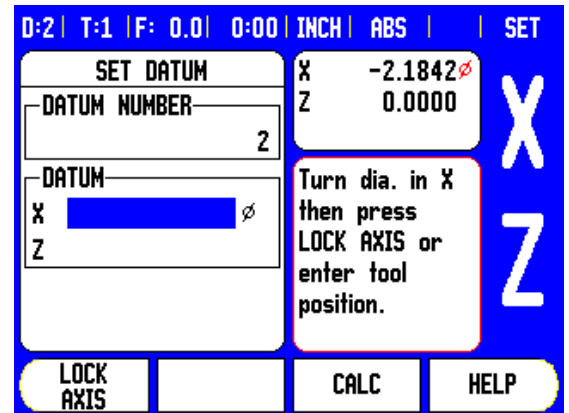

Taper Calculator Soft Key

Use the taper calculator to calculate taper angle. Refer to screen examples on the right.

You can calculate tapers either by entering dimensions from a print, or by touching a tapered workpiece with a tool or indicator.

Entry values:

For the taper ratio, calculation requires:

- Length of the taper
- Change in the radius of the taper.

For taper calculation using both diameters (D1, D2) and length requires:

- Starting diameter
- End diameter
- Length of the taper

Using Taper Calculator

- ▶ Press the CALC soft key: The soft key selection now changes to include the taper calculator functions.
- ▶ To calculate the taper angle using two diameters, and length between, press the taper: di/D2/l soft keys.
- ▶ First taper point, diameter 1, either enter a point using the numeric keys and press enter, or touch the tool to one point and press TEACH.
- ▶ Repeat this for the diameter 2 field. When using the TEACH key, the taper angle is automatically calculated. When entering data numerically, enter data into the length field, and press ENTER: The taper angle will appear in the angle field.
- ▶ To calculate angles using the ratio of the diameter, change to length, and press the taper: RATIO soft key.
- ▶ Using the numeric keys, enter data into the ENTRY 1, and ENTRY 2 fields.
- ▶ Press ENTER after each selection: The calculated ratio, and the angle will appear in their respective fields.

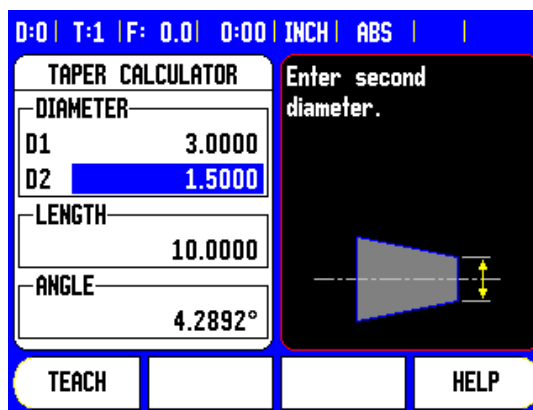
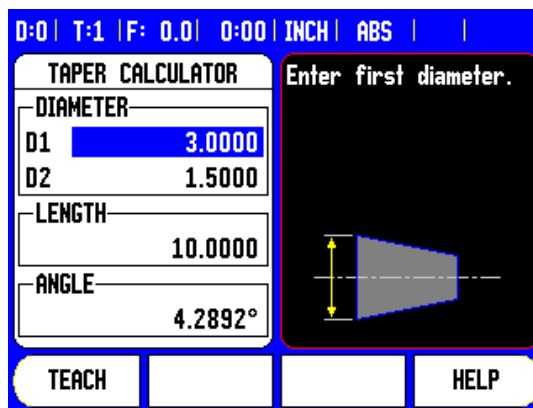

Presets

The functionality has been explained previously in this manual (see "Presets" on page 33). The explanation, and examples on those pages are based on a mill application. The basics of those explanations are the same for turning applications with two exceptions; Tool Diameter Offsets (R+/-), and Radius vs. Diameter inputs.

Tool diameter offsets have no applications with turning tools, so this functionality is not available while doing turning presets.

Input values can be either radius or diameter values. It is important to be sure the units you are entering for the preset agree with the state that the display is currently using. A diameter value is shown with a \emptyset symbol. The state of the display can be changed using the RAD/DIA soft key (available in both operating modes).

Radius/Diameter Soft Key

Drawings for lathe parts usually give diameter values. W1000 can display either the radius or the diameter for you. When the diameter is being displayed, the diameter symbol \emptyset is shown next to the position value.

Example:

- Radius display, position 1, X = .50
- Diameter display, position 1, X = \emptyset 1.0
- ▶ Press the RAD/DIA soft key to switch between radius display, and diameter display.

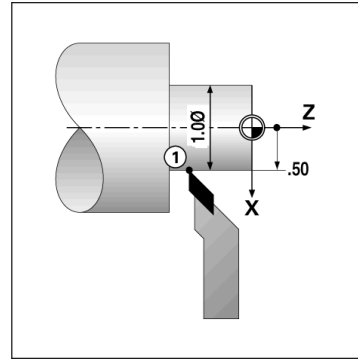

Vectoring

Vectoring breaks down the movement of the compound axis into the crossfeed or longitudinal axes. If you are turning threads, for example, vectoring lets you see the diameter of the thread in the X-axis display, even though you are moving the cutting tool with the compound axis handwheel. With vectoring enabled, you can preset the desired radius or diameter in the X-axis, so that you can “machine to zero”.



When vectoring is used, the top slide (compound) axis encoder must be assigned to the bottom display axis. The crossfeed component of movement of the axis will then be shown in the top display axis. The longitudinal component of movement of the axis will be shown in the middle display axis.

- ▶ Select VECTORING from Job Setup.
- ▶ Press the ON soft key to enable the vectoring feature.
- ▶ Arrow down to the Angle field to enter the angle between the longitudinal slide and top slide with 0° indicating the top slide is moving parallel to the longitudinal slide.
- ▶ Press ENTER.

Z Coupling

The W1000 Turning application provides a quick method for coupling the Z₀, and Z axes positions on a 3, or 4 axis system. The display can be coupled in either the Z₀, and Z displays.

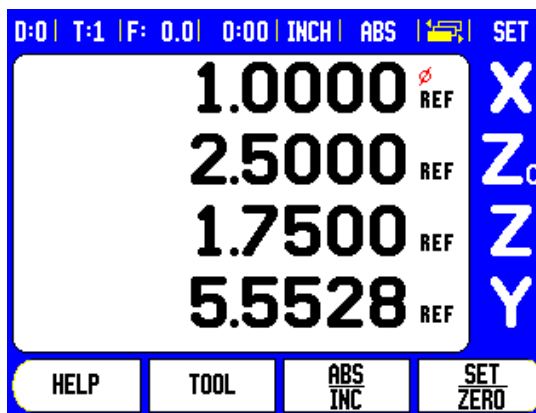
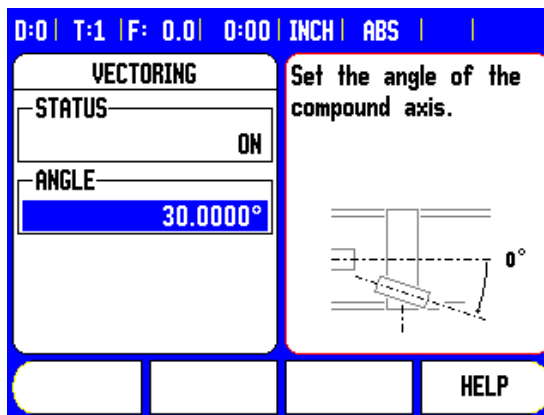

Enabling Z₀, and Z Coupling

To couple the Z₀, and Z axes and have the result displayed on the Z₀ display, press and hold the Z₀ key approximately 2 seconds. The sum of the Z positions will be displayed on the Z₀ display and the Z display will be blanked.

To couple the Z₀, and Z axes and have the result displayed on the Z display, press and hold the Z key for approximately 2 seconds. The sum of the Z positions will be displayed on the Z display and the Z₀ display will be blanked. The coupling is preserved in between power cycles.

Moving either Z₀, or Z inputs will update the coupled Z position.

When a position is coupled, the reference mark for both encoders must be found in order to recall the previous datum.

Disabling Z₀, and Z Coupling

To disable Z Coupling, press the axis key of the display that is blank. The individual Z₀, and Z display positions will be restored.

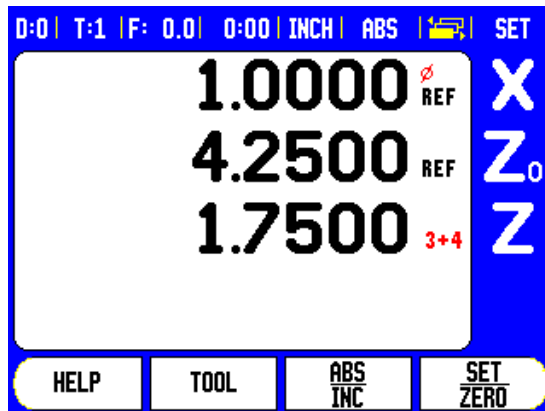

Thread Cycle

The Thread Cycle feature allows for data to be input into the W1000 to ease, and enhance thread cutting features on a lathe.



The Thread Cycle feature requires a rotary encoder be installed to the lathe thread cutting lead screw. The DRO requires this encoder to be set up on the third axis.

Access the Thread Cycle setup forms through the INSTALL SETUP soft key. High light Encoder Setup, and high light the Thread Cycle feature.

This section describes the Thread Cycle entry forms, and capabilities. The W1000 provides one user definable pattern which can be recalled, and executed from the DRO at anytime during operation.



Defined Thread Cycle pattern is remembered when power is cycled.







The VIEW soft key provides actual tool location during machining.

Soft Key Functions

The following soft keys are available for the Thread Cycle Feature.

Function	Soft key
Press the THREAD CYCLE key to access the forms, or begin the Thread Cycle feature previously set up.	THREAD CYCLE
The THREAD AXIS key is used to select the axis for the lead screw.	THREAD AXIS
Press THREADS PER INCH soft key to select English threads in the Thread Cycle setup form.	THREADS PER INCH
Press PITCH IN MM soft key to select Metric threads in the Thread Cycle setup form.	PITCH IN MM
Press DEPTH soft key to select thread depth cut in the Thread Cycle setup form.	DEPTH
Press NUMBER soft key to select number of threads in place of depth cut in the Thread Cycle setup form.	NUMBER

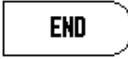
I - 4 Turning Specific Operations

Function	Soft key
Press FIRST PASS soft key to begin the thread cycle feature.	
Press NEXT PASS soft key to continue the thread cycle features next cut.	
Press START PASS soft key to begin the thread cycle features next cut.	
Press PREVIOUS PASS soft key if a cut is aborted during the thread cycle feature, and needs to be started again.	
Press FINISH PASS soft key when the feature has been setup in the thread cycle form for a final cut.	
Press END soft key to exit the thread cycle feature.	
Press VIEW soft key to view current tool location during the operation of the thread cycle feature.	

Thread cycle form:

- The Thread Cycle form is accessed by pressing the THREAD CYCLE soft key from the main screen (on page 2).
- Start point: beginning of the thread cut.
- End point: end of the thread cut.
- Passes: Enter the number of cutting passes.
- Finish: Enter the depth of the finish pass.
- Threads per inch, or Pitch in MM: For English threads, enter the number of threads per inch. For Metric threads, enter the pitch in millimeters.

1st Step: Enter data

- ▶ Locate the tool to the start point of the cut for each axes, and zero the DRO display for both X, and Z axes.
 - This location is the OD for the X axis for an outside thread, or the ID for an inside thread on the part. The location for the Z axis is at the start of the cut.
- ▶ Press the THREAD CYCLE soft key to open the form, and enter data.
 - The axes will be in the same mode as what the relative axis is set to; radius, or diameter

THREAD CYCLE		Enter the coordinates of the start point
START POINT		
X	0.0000 ϕ	
Z ₀	0.0000	
END POINT		
X	0.0000 ϕ	
Z ₀	0.0000	
TEACH		CALC
		HELP

Start Point

- ▶ **X:** Enter the coordinates for the start point as previously defined (0.0).
 - Typically 0.0 is the normal starting position.
- ▶ Press the DOWN arrow key.
- ▶ **Zo:** Enter the coordinates for the start point as previously defined (0.0).
 - Typically 0.0 is the normal starting position.
- ▶ Press the DOWN arrow key.

End Point

- ▶ **X:** Enter the final cut thread Diameter.
 - This is the small OD for external threads, and the large ID for internal threads.
- ▶ Press the DOWN arrow key.
- ▶ **Zo:** Enter the end point of the thread (thread length).
- ▶ Press the DOWN arrow key.

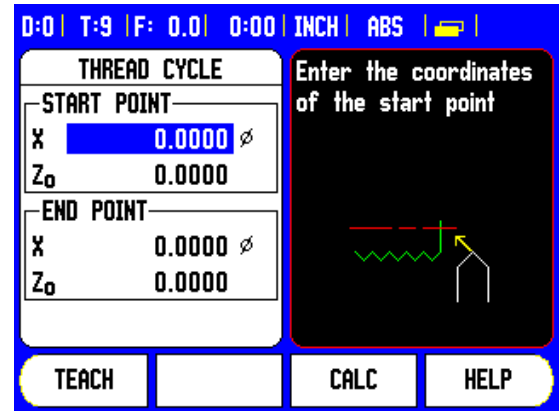

Passes

- ▶ NUMBER or DEPTH will be displayed. Toggle the soft key for user preference.
- ▶ NUMBER: Enter the number of normal passes, or.
- ▶ DEPTH: Enter the depth dimension for a normal pass.
- ▶ FINISH PASS: (optional) Enter the depth dimension for the finish pass, or leave blank.
 - Finish pass is in addition to the normal passes, and is included in the total cut depth.
- ▶ Press the DOWN arrow key.

Thread

- ▶ Select either INCH, or MM by toggling the soft key.
- ▶ Enter the number of threads per inch, or pitch in MM.
 - The Thread Cycle parameters are now entered.
- ▶ Press ENTER to run the program.
- ▶ Press the C key to exit the program, and return to the normal display.

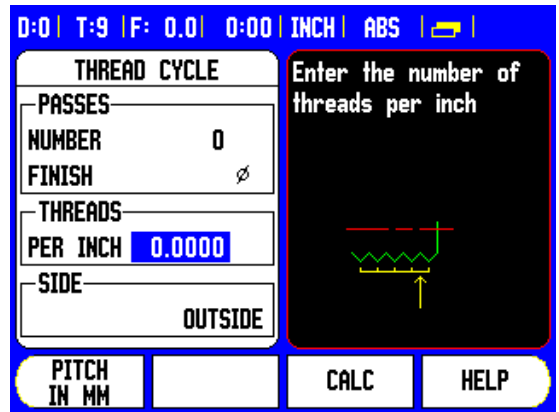
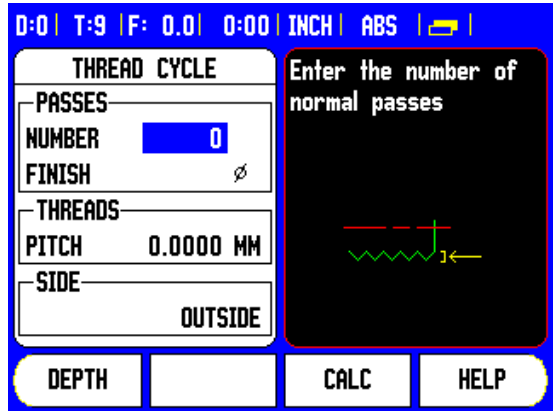

Running the Thread Cycle Program

The following messages will appear on the screen while running the thread cycle program.

- ▶ Move X, and Z to 0.0.
- ▶ Ready to engage thread lever.
- ▶ Disengage when X,Z = 0.
- ▶ Press FIRST PASS.
- ▶ Press START PASS.
- ▶ Press NEXT PASS.
- ▶ Engage lever.
- ▶ Press FINISH PASS.

The Thread Bar **T** displays the rotation of the lead screw relative to an established mark. This mark is established when the First Pass is initially executed. All subsequent passes can now be engaged using the Thread Bar indicator **1** when located at the center mark.

- ▶ Press THREAD CYCLE soft key to open the form.
- ▶ Press the ENTER key to start the program.
 - A message is displayed to "Move X, Z₀ to 0,0".
- ▶ Move the longitudinal axis to zero.
- ▶ Move the cross feed axis to zero.
 - A message will be displayed "Press First Pass".

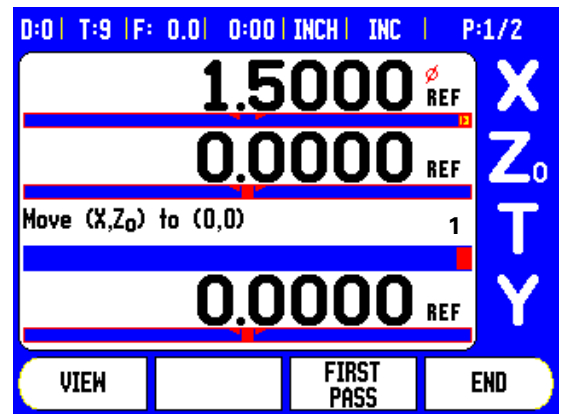

First Pass

- ▶ Press the FIRST PASS soft key.
 - Do not move the carriage manually.
- ▶ Watch the machine dial, and engage the lever for the first pass on the appropriate number (even, or odd).
 - If a false start occurs at any time, disengage the lever, backing off the cross feed at the same time. Press the PREVIOUS PASS soft key to restart the procedure.

Remaining Passes

- ▶ Keep hand on lever while the carriage is moving. The DRO will count down.
- ▶ Disengage lever, and back off the cross feed at the same time when the DRO reads 0.0, and the screen message states “Disengage Lever”.
- ▶ With lever disengaged, press the NEXT PASS soft key.
- ▶ Move the axes back to the start position. Move Z to 0.0, then move X to 0.0,. The message “Press Start Pass” will be on the screen.
- ▶ When ready, press the START PASS soft key. Watch the “Thread Bar Indicator” **1** and engage the lever when it reaches the center mark.
- ▶ Repeat this procedure until all normal passes are completed.
 - If a finish pass step was created, the FINISH PASS soft key will appear.
- ▶ Press the FINISH PASS soft key, and execute the same as the previous passes.

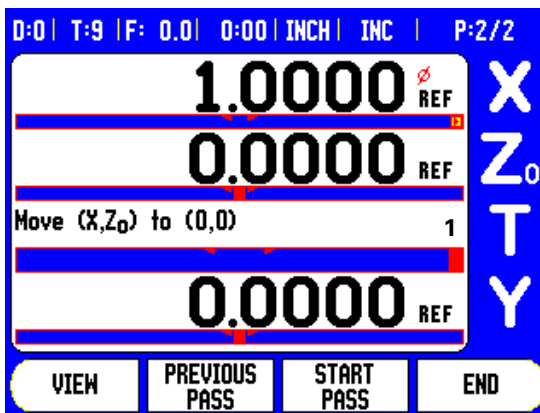
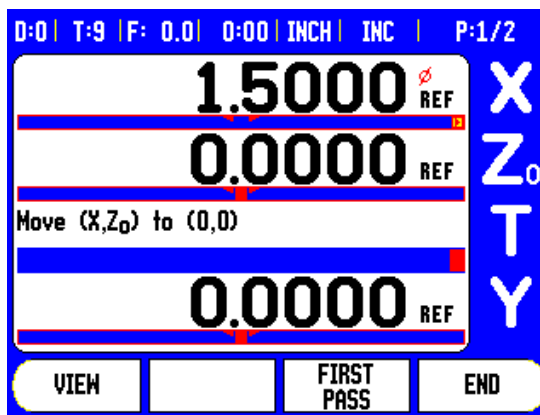

I - 5 Programming W1000

Overview

The basic machining operations available in the DRO mode (i.e. tool selection, preset, hole patterns) can also be used to create a program. A program is a sequence of one or more machining operations. Programs can be executed a number of times and saved for later use.

Each machining operation is a separate step with the program. A program can have up to 250 steps. The program listing shows the step numbers, and the associated machining operations.

Programs can be saved to internal storage, which isn't lost when power is off. The readout can hold up to 8 programs in internal storage. Programs can also be saved to external storage on a PC using the export and import functions.

To access the Program Mode, from the DRO mode, press the PROGRAM soft key. A listing of the current program loaded (or a blank listing) is displayed. Also displayed are the soft keys VIEW, FEATURES, RUN, HELP, PROGRAM FUNCTIONS, and STEP FUNCTIONS.





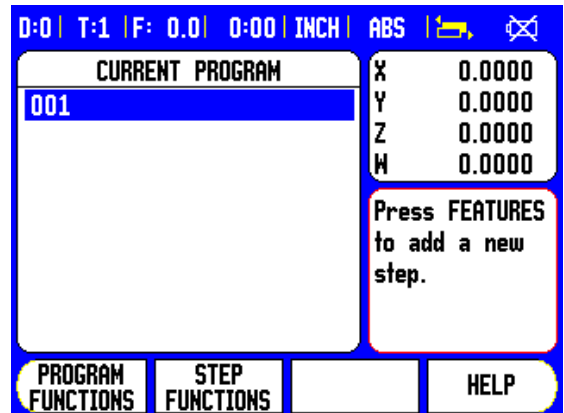

Press the LEFT, or RIGHT ARROW keys to view more soft key choices.

PROGRAM



Program Mode Soft key functions

The following soft keys are available while in the Program Mode feature.

Function	Soft key
Press to toggle between the current program listing with DRO (ABS) positions and a graphical view of the programmed part (milling only).	
Press to show, and select the available programming features: TOOL, DATUM, PRESET, and for milling: POSITION, CIRCLE PATTERN, LINEAR PATTERN, INCLINE MILL, and ARC MILL.	
Press to execute the program from the current highlighted step.	
Press to display help relating to the program mode.	
Press to show the available program functions: LOAD, SAVE, DELETE, CLEAR, IMPORT, and EXPORT.	
Press to show the available step functions: CLEAR STEP, and EXPLODE STEP (milling only).	

View Soft Key

The VIEW soft key is used to toggle between the program listing with the DRO (ABS) positions, and graphical view of the part program.

When Program Mode is selected, the view defaults to the program listing view.





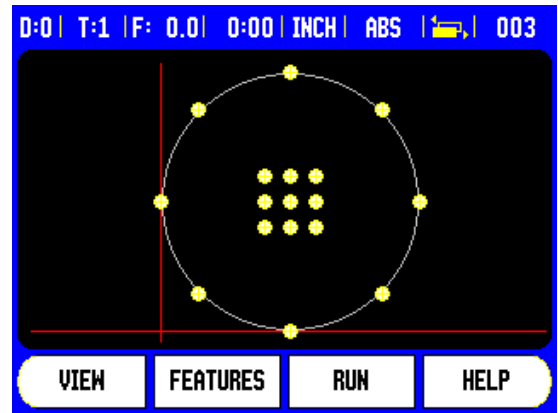



Press the **VIEW** soft key to show a graphical view of the part program. The datum, position, circle pattern, and linear pattern steps have a graphical view. The features of the part are scaled to the size of the window.

- The datum is drawn as a vertical and horizontal line representing the (0,0) location.
- The position and holes of a hole pattern are drawn as circles. The diameter of the programmed tool is used to draw the holes.



Feature Soft Key functions

To access the available features, press **PROGRAM**, then the **FEATURES** soft key. The following soft keys will be available. Use the **LEFT**, and **RIGHT** arrow keys to toggle through the menu. Note that in program mode the **C** key will clear the entry

Function	Soft key
Press to enter a Tool step into the program. See "Tool Soft Key" on page 22..	
Press to enter a Datum step. See "Datum Soft Key" on page 28..	
Press to enter a Preset step into the program. See "Presets" on page 33..	
Press to enter a Position step (mill only).	
Press to enter a Circle Pattern step (mill only). See "Circle, and Linear Patterns" on page 38..	
Press to enter a Linear Pattern step (mill only). See "Circle, and Linear Patterns" on page 38..	
Press to enter an Incline Mill step (mill only). See "Incline, and Arc Milling Table Entry" on page 45..	
Press to enter an Arc Mill step (mill only). See "Arc Milling" on page 47.	

Tool Soft Key

The Tool step is used to select the tool (from the Tool Table) that will be used by the subsequent steps in the program. Open the Tool Table by pressing the TOOL soft key. Select the desired tool, then press the USE TOOL soft key. The step that was highlighted in the program will become a Tool step.

Datum Soft Key

The datum step is used to select the datum to be used by subsequent steps in the program. Open the Datum form by pressing the DATUM soft key. Enter the desired datum number (0-9), then press ENTER. The step that was highlighted in the program will become a Datum step.

Preset Soft Key

The preset step is used to enter the nominal (target) position to move to from within a program. Open the Preset form by pressing the PRESET soft key. Select the desired information, then press ENTER. The step that was highlighted in the program will become a Preset step.

Position Soft Key (mill only)

The Position step is used to enter the nominal (target) position to move to "for the machine and tool axes" (X, Y, & Z) from within a program. Open the Position form by pressing the POSITION soft key. Enter the nominal positions for the machine axes, and the depth (optional) for the tool axis, then press ENTER. The depth is optional, and can be left blank. The step that was highlighted in the program will become a Position step.

Circle Pattern Soft Key (mill only)

The CIRCLE PATTERN soft key is used to specify the parameters of a circle pattern from within a program. Open the Circle Pattern table by pressing the CIRCLE PATTERN soft key. Use the UP, and DOWN arrow keys to select the desired pattern, then press USE. The step that was highlighted in the program will become a Circle Pattern step.

To modify the selected pattern, press ENTER, or the EDIT soft key. In the form; enter the new pattern parameters, then press ENTER.

Linear Pattern Soft Key (mill only)

The LINEAR PATTERN soft key is used to specify the parameters of a linear pattern from within a program. Open the Linear Pattern table by pressing the LINEAR PATTERN soft key. Use the UP, and DOWN arrow keys to select the desired pattern, then press USE. The step that was highlighted in the program will become a Linear Pattern step.

To modify the selected pattern, press ENTER, or the EDIT soft key. In the form; enter the new pattern parameters, then press ENTER.

Incline Mill (mill only)

The INCLINE MILL soft key is used to provide a way to machine a flat diagonal surface from within a program. Open the Incline Mill Table by pressing the INCLINE MILL soft key. Use the UP, and DOWN arrow keys to select the desired incline mill feature, then press USE. The step that was highlighted in the program will become an Incline Mill step.

To modify the selected pattern, press ENTER, or the EDIT soft key. In the form; enter the new pattern parameters, then press ENTER.







Arc Mill (mill only)

The ARC MILL soft key is used to provide a way to machine a rounded surface from within a program. Open the Arc Mill Table by pressing the ARC MILL soft key. Use the UP, and DOWN arrow keys to select the desired arc mill feature, then press USE. The step that was highlighted in the program will become an Arc Mill step.

To modify the selected pattern, press ENTER, or the EDIT soft key. In the form; enter the new pattern parameters, then press ENTER.



Program Function Soft keys

The following Program Function soft keys are available while in Program Mode

Function	Soft key
Press to load a previously saved program into current program.	
Press to save and name the current program.	
Press to delete a saved program permanently.	
Press to clear current program memory.	
Press to Import a program into current program memory over the RS -232 port from a PC.	
Press to Export the current program over the RS-232 port to a PC.	

Step Function Soft keys

The following Step Function soft keys are available while in Program Mode.

Function	Soft key
Press to clear the highlighted step from current program.	
Press to explode highlighted step into position steps. This applies only to Circle and linear Patterns.	

Editing, and moving through a program

- ▶ Press UP/DOWN arrow keys to move the highlighted cursor to the next or previous step in the program listing.
- ▶ To move to a specific step in the program use the numeric keys and enter the desired step number (i.e. 005).
- ▶ To insert a new step in the program, highlight the step in the program listing, press the FEATURES soft key and select the desired feature.



The highlighted step and all of the following steps are shifted down one step in the program listing, and the new step is inserted at the highlighted step.

- ▶ To edit the step currently highlighted, press the ENTER key.
- ▶ To clear a step, press STEP FUNCTIONS soft key, then press the CLEAR STEP soft key. A YES/NO confirmation is required before the step will be removed from the program listing.



When a step is deleted from the program listing all of the steps following the deleted step are shifted up one step in the program listing

- ▶ To run the current program, press the RUN soft key. The program will be executed from the current step that is highlighted.

I - 6 Executing a Program

To run a program, use the UP/DOWN arrow keys, or use numeric keys to select the program step to begin running. Press RUN. The distance-to-go view is displayed, and the soft keys VIEW, PREVIOUS STEP, NEXT STEP, and END, are shown. The number of the current step being executed is also displayed on the status bar.

Run Soft Keys

Function	Soft key
Press to see the graphical view of the circle or linear pattern that is being executed.	VIEW
Press to go to previous step in program	PREVIOUS STEP
Press to go to next step in program.	NEXT STEP
Press to go to next hole in program.	NEXT HOLE
Press to go to previous hole in program	PREVIOUS HOLE
Press to end program execution	END

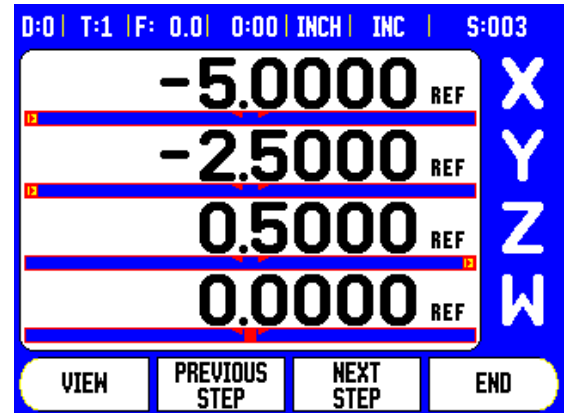

Executing Steps

When a TOOL step is executed, the tool number on the status bar flashes. This indicates that the tool needs to be changed to the tool number shown on the status bar.

When a DATUM step is executed, the datum number on the status bar flashes indicating that the datum is about to be changed and this will be the datum used for the following program operations.

When a POSITION step is executed, the display show the distance-to-go for the machine and tool axes. Move the axes until the positions read 0.0, then press NEXT STEP.

When a PRESET step is executed, the display shows the distance-to-go. Move the axes until the positions read 0.0, then press NEXT STEP.

When a CIRCLE PATTERN, or LINEAR PATTERN step is executed, the display shows the distance-to-go to get to each hole in the pattern. Move the axes until the positions read 0.0, then press NEXT HOLE.

Once the correct operation is performed, press NEXT STEP to get the next step in the program and execute it. Pressing the PREVIOUS STEP will execute the previous step in the program.

If the current step being executed is a circle or linear pattern, the VIEW, PREVIOUS HOLE, and NEXT HOLE soft keys are shown. Pressing NEXT HOLE will display the distance-to-go for the next hole in the pattern. Once all holes in the step have been executed the soft keys become PREVIOUS STEP, and NEXT STEP. Press the VIEW soft key to toggle between the distance-to-go view, and the hole pattern graphic view.

If the current step being executed is for incline milling, or arc milling, the VIEW, PREVIOUS PASS, and NEXT PASS soft keys are shown. The screen switches to the DRO (INC) view, and shows the incremental distance from the start point. After moving to the start point, Press NEXT PASS the incremental display shows the distance from the next pass along the line's (or arc's) contour. When the last pass of the milling operation is executed, the NEXT PASS soft key changes to NEXT STEP.

Pressing END or executing a blank step in the program completes the run mode operation and returns to the Program Mode.

W1000



Technical Information

II - 1 Installation Setup

Installation Setup Parameters

To locate the Installation Setup screen from the normal operating display:

- ▶ Press the RIGHT, or LEFT arrow key until the SETUP soft key is displayed
- ▶ Press the SETUP soft key.
 - The Job Setup screen is now displayed, and the INSTALL. SETUP soft key is displayed.
- ▶ Press the INSTALL. SETUP soft key, and enter the passcode.
 - The Installation Setup screen is now displayed.

Installation Setup parameters are established during the initial installation, and do not often change. For this reason, the installation setup parameters are protected by the passcode.

See "Readout Parameter Access Code" on page iii

The Installation Setup Data can be imported, or exported using the IMPORT/EXPORT soft key

Exporting the current Installation Setup:

- ▶ Press the SETUP soft key.
- ▶ Press the INSTALL SETUP soft key.
- ▶ Press the IMPORT/EXPORT soft key.
- ▶ Press the EXPORT soft key.

Importing a new Tool Table

- ▶ Press the SETUP soft key.
- ▶ Press the INSTALL SETUP soft key.
- ▶ Press the IMPORT/EXPORT soft key.
- ▶ Press the IMPORT soft key.

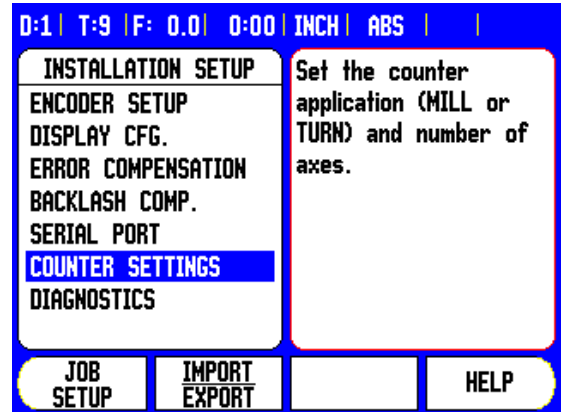

Encoder Setup

The ENCODER SETUP is used to set the encoder: resolution, type (linear, rotary), count direction, and reference mark type.

- ▶ The cursor will default to the ENCODER SETUP field upon opening Installation Setup. Press ENTER. This opens a list of up to 4 possible encoders, labeled INPUT X1, X2, X3, and X4.



The THREAD CYCLE setup field will only appear if the readout is configured for TURN mode.

- ▶ Scroll to the encoder input to be added, or changed, and press ENTER.
- ▶ The ENCODER SIGNAL field will automatically be determined.
- ▶ Cursor will be in the ENCODER TYPE field, select the encoder type by pressing the LINEAR/ROTARY soft key.



In TURN mode, the THREAD CYCLE feature requires that the third axes be setup for the lead screw using a rotary encoder.

- ▶ Arrow down to the RESOLUTION field.
- ▶ Press COARSER, or FINER soft keys when using linear encoders to select the encoder's resolution in μm (10, 5, 2, 1, 0.5). The exact resolution can also be typed in using the numeric key pad.
 - Rotary encoders require the number of counts per revolution to be entered using the numeric key pad.
- ▶ Arrow down to the REFERENCE MARK field.
- ▶ Toggle the REF MARK soft key.
 - Select NONE for no reference signal, SINGLE for single reference mark, or POSITION TRAC for an encoder with the Position-Trac™ feature.



Select NONE for the third axes if it is being setup for the THREAD CYCLE feature.

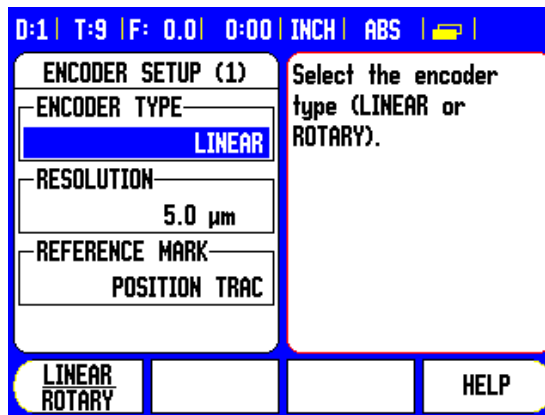

- ▶ Arrow down to the COUNT DIRECTION field.
- ▶ In the COUNT DIRECTION field, select the count direction by pressing the POSITIVE/NEGATIVE soft key.
 - When the encoder's count direction matches the operators count direction, select positive. When they do not match, select negative.



The encoder resolution and count direction can also be established by just moving each axis.

- ▶ Arrow down to the ERROR MONITOR field.
- ▶ In the ERROR MONITOR field, select whether the system will monitor, and display encoder errors by selecting ON, or OFF. ON allows the DRO to monitor Counting errors. The types of Counting errors are contamination errors (when the signal to the encoder falls below a set limit), and frequency error (when the signal frequency exceeds the set limit).
 - When an error message occurs, press the C key to remove it.
- ▶ Press ENTER to save the settings entered, and move to the next encoder setup, or press the C key to remove them.
- ▶ To exit, and save settings, press ENTER then JOB SETUP.

Thread Cycle Setup:

To use the Thread Cycle feature, data now needs to be entered into the Thread Cycle form.

- ▶ High light Thread Cycle, and press ENTER.
- ▶ Enter the axis for the lead screw by either toggling the THREAD AXIS soft key, or using the numeric key pad. This will be the same axis as the rotary encoder axis).
- ▶ Enter the threads per inch of the lead screw. The Thread Cycle input data is now complete. Press ENTER to exist the form, and save.
- ▶ Press ENTER to save the settings entered, and move to the next encoder setup, or press the C key to remove them.
- ▶ To exit and save setting, press ENTER, then JOB SETUP.

Display Configuration

The Display Configuration form is where which axes can be selected for display, and in what order. The following additional setups are also available.

- ▶ Scroll to the desired display, and press ENTER.
- ▶ Press the ON/OFF soft key to turn the display on, or off. Press the LEFT, or RIGHT arrow key to select the axis label.
- ▶ Scroll to the Input field. Press the numeric key associated with the encoder input on the back of the unit.
- ▶ Press the + or - soft keys to couple a second input with the first. The input numbers are displayed next to the axis label indicating that the position is a coupled position (i.e. "2 + 3").
- ▶ Scroll to the Display Resolution field. Press the COARSER, or FINER soft keys to select the display resolution.
- ▶ Scroll to the Angle Display field if the encoder type is set to Rotary. Press the ANGLE soft key to display the position as 0° - 360° , $\pm 180^{\circ}$, \pm infinity, or RPM.

Error Compensation

The distance a cutting tool travels, measured by an encoder, can in certain cases, differ from the actual tool travel. This error can occur due to ball screw pitch error, or deflection and tilting of axes. This error can either be linear, or non-linear. You can determine these errors with a reference measurement system, such as gauge blocks, laser, etc. From an analysis of the error, it can be determined which form of compensation is required, linear, or non-linear error.

The W1000 provides the opportunity to compensate for these errors, and each axis can be programmed separately with the appropriate compensation.



Error compensation is only available when using linear encoders.

Linear Error Compensation

Linear error compensation can be applied, if the results of the comparison with a reference standard show a linear deviation over the whole measuring length. In this case the error can be compensated by the calculation of a single correction factor.

To calculate the linear error compensation use this formula:

Correction factor **LEC = (S – M) x 10⁶ ppm** with:

S measured length with reference standard

M measured length with device at axis

Example:

If the length of the standard you used is 500 mm, and the measured length along the X-axis is 499.95, then the LEC for the X-axis is 100 parts per million (ppm).

LEC = (500 – 499.95) x 10⁶ ppm = 100 ppm (rounded to the nearest whole number).

- ▶ Once determined, the encoder's error information is entered directly. Press the TYPE soft key to select LINEAR compensation.
- ▶ Enter the compensation factor in parts per million (ppm), and press the ENTER key.

Automatic Linear error compensation

The correction factor may be calculated automatically using a standard gauge block. Press the AUTO CALC soft key. In the Standard Field, enter the length of the standard plus any tool offset (tool, or edge finder diameter), which is not required when measuring from the same direction.

To measure the standard using an edge finder, touch one end of the block. The Measured Field shows 0. Move to the second edge, and touch the other end of the gauge block. The measured size, plus any tool offset appears in the field.

To measure the standard using a tool, touch one end of the block, and press TEACH. The Measured Field shows 0. Move to the second edge, and touch the other end of the gauge block. Press TEACH. The measured size, plus any tool offset appears in the field.

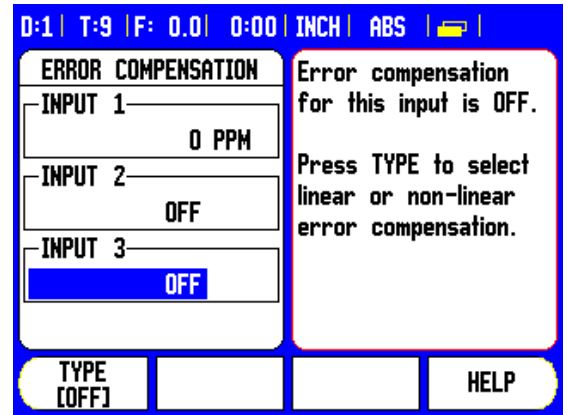

The Factor Field shows the calculated correction factor based on the measured and standard value.

Press the ENTER key to exit the form and transfer the calculated factor to the error compensation form, or C to exit without transferring the factor.

Non-Linear Error Compensation

Non-linear error compensation should be applied if the results of the comparison with a reference standard show an alternating, or oscillating deviation. The required correction values are calculated, and entered in a table. The W1000 supports up to 200 points per axis. The error value between two entered adjacent correction points is calculated with linear interpolation.



Non-linear error compensation is only available on scales with reference marks. If non-linear error compensation has been defined, no error compensation will be applied until the reference marks have been crossed.

Setup procedure for Non-linear Error

- The encoder has an inherent count direction. This may not reflect the user defined count direction, and is only required for determining the non-linear error compensation.

To establish the inherent count direction for any installed encoder on a given axis, complete the following:

- ▶ Open the Encoder Setup form, and select the encoder on the axis that is to be addressed.
- ▶ Arrow down to high light the count direction.
- ▶ Use the POSITIVE/NEGATIVE soft key and select Positive. Press enter.
- ▶ Using the C key, return to the main display
- ▶ Move the axis that the encoder is mounted on, and note the direction of movement required for the positive direction.
- The encoder's inherent count direction is now established.



Single reference mark encoders must cross the same reference mark each time the DRO is powered on.

D:1 T:9 F: 0.0 0:00 INCH ABS			
INPUT 1: MEASURED = ERROR			
SPACING = 1.0000			
START POINT = -9.3986			
000	=	0.0000	= 0.010000
001	=	1.0000	= 0.020000
002	=	2.0000	= 0.020000
003	=	3.0000	= 0.000000
004	=	4.0000	= 0.010000
005	=	5.0000	= -----
VIEW		CLEAR TABLE	IMPORT EXPORT
HELP			

Starting a Non-Linear Error Compensation Table

- ▶ Select Non-linear by pressing the TYPE soft key.
- ▶ To start a new error compensation table, first press the EDIT TABLE soft key.
- ▶ All correction points (up to 200) are equally spaced from the start point. Enter the distance between each of the correction points. Press the DOWN arrow key.
- ▶ Enter the table's start point. The start point is measured from the scale's reference point. If this distance is not known, you can move to the location of the start point, and press TEACH POSITION. Press ENTER.



Pressing ENTER will save the spacing, and start point information.

Configuring the Compensation Table

- ▶ Press the EDIT TABLE soft key to view the table entries.
- ▶ Use the UP, or DOWN arrow keys, or the numeric keys to move the cursor to the correction point to be added or changed. Press ENTER.
- ▶ Enter the known error which exists at this point. Press ENTER.
- ▶ When completed, press C key to exit the table and return to the Error Compensation form.

Reading the Graph

The error compensation table may be viewed in table or graphical formats. The graph shows a plot of a translation error vs. measured value. The graph has a fixed scale. As the cursor is moved through the form, the location of the point on the graph is indicated with a vertical line.

Viewing the Compensation Table

- ▶ Press the EDIT TABLE soft key.
- ▶ To switch between the table and graph views, press the VIEW soft key.
- ▶ Press the UP, or DOWN arrow keys or the numeric keys to move the cursor within the table.

The error compensation table data may be saved to or loaded from a PC via the Serial port.

Automatic Non Linear error compensation

The correction factor may be calculated automatically using a standard gauge block. To select automatic calculation, move the cursor to Spacing, and press ENTER. Press the MANUAL/AUTOMATIC soft key to select automatic which is now displayed in the Spacing Field. Move the cursor to any entry within the table (000-199), and press ENTER.

In the Standard Field, enter the length of the standard plus any tool offset (tool or edge finder diameter), which is not required when measuring from the same direction.

To measure the standard using an edge finder, touch one end of the block. The Measured Field shows 0. Move to the second edge, and touch the other end of the gauge block. The measured size, plus any tool offset appears in the field.

To measure the standard using a tool, touch one end of the block, and press teach. The Measured Field shows 0. Move to the second edge, and touch the other end of the gauge block. Press TEACH. The measured size, plus any tool offset appears in the field.

The Factor Field shows the calculated correction factor based on the measured and standard value.

Press the ENTER key to exit the form and update the table with information on the new interval, or C to exit without transferring the factor. A compensation table may also be imported, or the new table can be exported.

Exporting the current Compensation Table

- ▶ Press the IMPORT/EXPORT soft key.
- ▶ Press the EXPORT soft key.

Importing a new Tool Table

- ▶ Press the IMPORT/EXPORT soft key.
- ▶ Press the IMPORT soft key.

Backlash Compensation

When using a rotary encoder with a lead screw, a change in direction of the table might cause an error in the displayed position due to clearances within the lead screw assembly. This clearance is referred to as backlash. This error can be compensated for by inputting the amount of backlash within the lead screw into the Backlash Compensation feature. See screen to the right.

If the rotary encoder is ahead of the table (displayed value is greater than the table's true position), this is called positive backlash, and the value entered should be the positive value of the amount of error.

No Backlash Compensation is 0.000.

D:1 T:9 F: 0.0 0:00 INCH ABS			
BACKLASH COMP.		Specify the amount of backlash between the encoder and the machine.	
INPUT 1	<input type="text" value="0.2"/>		
INPUT 2	<input type="text" value="OFF"/>		
INPUT 3	<input type="text" value="OFF"/>		
ON			HELP
OFF			

Counter Settings

The COUNTER SETTINGS feature is the parameter where the operator defines the user application for the readout. The choices are for milling, or turning applications.

A FACTORY DEFAULT soft key appears in the Counter Settings choice of options. When pressed, the configuration parameters (based on either mill, or turn) will be reset to factory defaults. A responses of YES to set parameters to factory default settings, or NO to cancel, and return to previous menu screen is required.

The Number of Axes field sets the number of axes needed. A 1, 2, OR 3 soft key will appear to choose between either 1, 2 or 3 axes.

D:1 T:9 F: 0.0 0:00 INCH ABS			
COUNTER SETTINGS		Set the application to MILL or TURN.	
APPLICATION	<input type="text" value="MILL"/>		
NUMBER OF AXES	<input type="text" value="4"/>		
POSITION RECALL	<input type="text" value="OFF (X)"/>		
MILL	FACTORY		HELP
TURN/GP	DEFAULTS		

The Position Recall feature, when it is "ON", will store the last position of each axis when power was turned off, and then redisplay that position once power is turned back on.



Note that any movement that occurs while power is off will be lost. Whenever power has been off it is recommended to re-establish workpiece datums using the Reference Mark Evaluation procedure. .

Diagnostics

The DIAGNOSTICS provides access for testing the keypad, and edge finders.

Keypad Test

An image of the keypad provides an indication when a switch is pressed, and released.

- ▶ Press each hard, and soft key to test. A dot will appear on each key when it has been pressed indicating that it is operating properly.
- ▶ Press the C key two times to exit the keypad test.

Edge Finder Test

- ▶ To test the edge finder, touch the edge finder to a part. An * will appear on the display screen above the corresponding edge finder in use. Grounding type edge finder symbol is to the left, and an electronic edge finder symbol is to the right.

Display Test

- ▶ To test the display, press the ENTER key to cycle through the available colors.

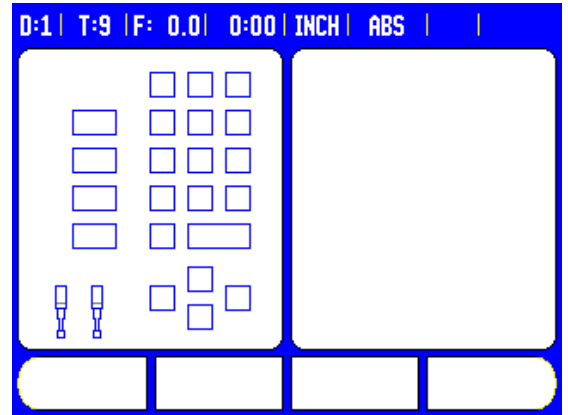

II - 2 Data Interface

The W1000 data interface includes the RS-232 serial port. The serial port supports both bi-directional data communications which allows data to be exported to, or imported from an external device. Also, external operations via the data interface.

Data which can be exported from the W1000 to an external serial device includes:

- Job, and Installation configuration parameters.
- Non-linear error compensation tables.
- Measured value output (display values, or probing functions).

Data which can be imported into W1000 from an external device includes:

- Remote key commands from an external device
- Job, and installation configuration parameters
- Non-linear error compensation tables

For operations that support data transfer, an IMPORT/EXPORT soft key is available. See "Import/Export" on page 19.

To export, or import data between the W1000 and a personal computer, the PC can use a common terminal communications software such as Hyperterminal. This software processes the data being sent, or received over the serial cable link. All data transferred between the W1000, and the PC is in ASCII text format.

To export data from the W1000 to a PC, the PC must first be made ready to receive the data to save it to a file. Setup the terminal communication program to capture ASCII text data from the COM port to a file on the PC. After the PC is ready to receive, start the data transfer by pressing the W1000 IMPORT/EXPORT soft key.

To import data into the W1000 from a PC, the W1000 must first be made ready to receive the data.

- ▶ Press the W1000 IMPORT/EXPORT soft key.
- ▶ After the W1000 is ready, setup the terminal communications program on the PC to send the desired file in ASCII text format..



The W1000 does not support communication protocols such as Kermit or Xmodem.

Serial Port

The RS-232-C / V.24 data interface serial port is located on the rear panel.

The following devices can be connected to this port:

- Printer with serial data interface.
- Personal computer with serial data interface.

A printer, or computer may be connected to the serial port. Part programs, and configuration files may be sent to a printer, or computer. Remote commands, remote key codes, part programs, and configuration files may be received from a computer.

For operations that support data transfer, an IMPORT/EXPORT soft key will be available.

- ▶ The BAUD Field can be set to 300, 600, 1 200, 2 400, 9 600, 19 200 38 400, 57 600, or 115 200 by using the soft keys.
- ▶ The parity can be set to NONE, EVEN, or ODD using the LOWER, or HIGHER soft key.
- ▶ Data Bits in the Format Field can be set to 7, or 8 using the soft key provided.
- ▶ The Stop Bits Field can be set to 1, or 2 using soft key.
- ▶ Line Feed Field can be set to YES if the external device needs a line feed to follow a carriage return.
- ▶ Output tail is the number of carriage returns that will be sent at the end of the measured value output transmission. The output tail is initially 0, and can be set to a positive integer value (0 - 9) by using the numeric hard keys.

The serial port settings will be retained on a power cycle. There is no parameter to enable, or disable the serial port. Refer to Data Interface section for cable connection, and pin assignments.

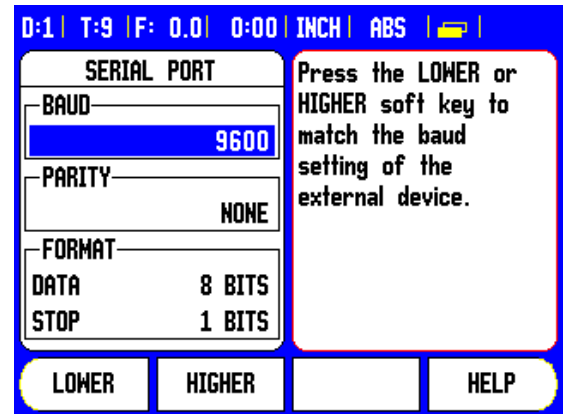

II - 3 Installation and Electrical Connections

Installation

The DRO is mounted to a tilt/swivel feature: See "DRO Dimensions" on page 102.

Electrical requirements

Voltage 100 - 240 Vac

Power 30 VA max.

Frequency 50/60 Hz (+/- 3Hz)

Fuse 630 mA/250 Vac, 5 mm x 20 mm, Slo-Blo (line and neutral fused)

Environmental

Operating temperature 0° to 45°C (32° to 113°F)

Storage temperature -20° to 70°C (-4° to 158°F)

Mechanical weight 2.6 kg (5.2 lb.)

Protective earthing (grounding)



It is necessary to connect the protective conductor terminal on the rear panel to the star point of machine ground as shown in figure to the right.

Preventative maintenance

No special preventative maintenance is necessary. For cleaning, wipe lightly with a dry lint-free cloth.

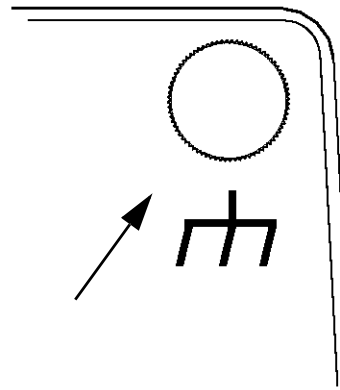

II - 4 I/O Connections

Encoders are plugged into connectors marked Inputs 1, 2, 3, & 4.

Pin layout for Electronic Edge Finder

Pin	Assignment
1	0V (Inner shield)
2	Stand By
3	
4	
5	
6	+5V
7	
8	0V
9	
10	
11	
12	
13	Switch Signal
14	
15	
Housing	External Shield

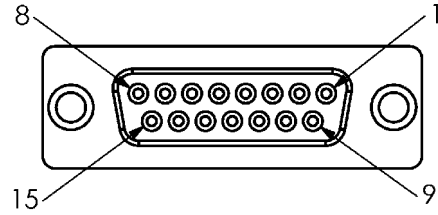

15 Pin receptacle connector for Edge Finder.

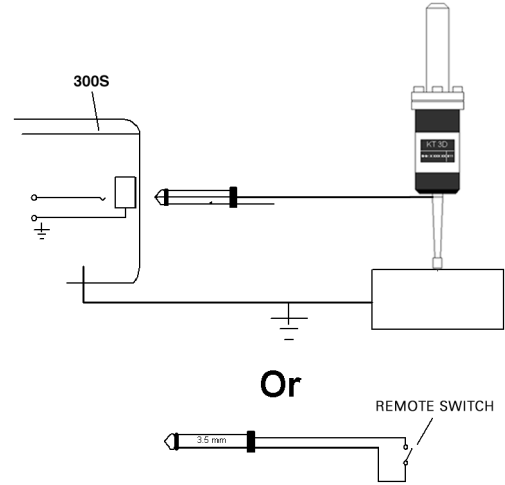

Grounding Edge Finder / Remote Switch

Wiring the Serial communication cable

The wiring of the serial communication cable depends on the device being connected (see technical documentation for external device)

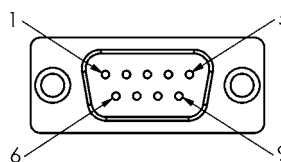

Pin layout of RS-232-C / V.24 data interface.

Pin assignment

Pin	Assignment	Function
1	No assignment	
3	TXD	- Transmitted Data
2	RXD	- Received data
7	RTS	- Request to send
8	CTS	- Clear to send
6	DSR	- Data set ready
5	SIGNAL GND	- Signal ground
4	DTR	- Data terminal ready
9	No assignment	

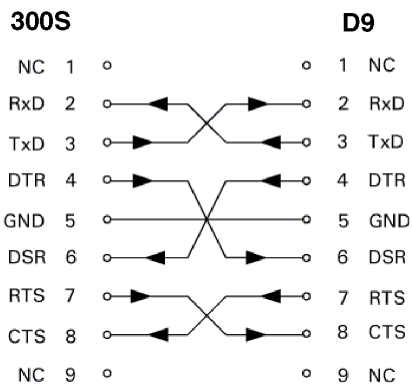

Pin connection for serial port with handshaking.

Signal

Signal	Signal Level "1" = "active"	Signal level = "inactive" "0"
TXD, RXD	-3 V to - 15 V	+3 V to + 15 V
RTS, CTS DSR, DTR	+3 V to + 15 V	-3 V to - 15 V

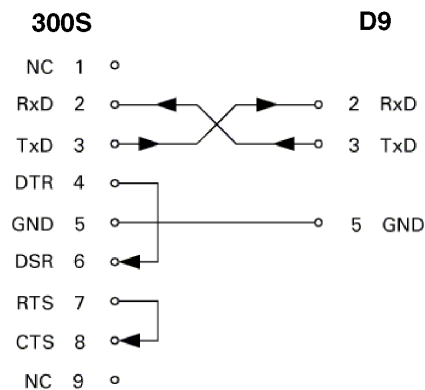

Pin connection for serial port without handshaking.

II - 5 Remote Switch Data Output

The remote switch (pendant or footswitch), or **Ctrl B** (sent over serial interface), will transmit the currently displayed values in either Actual Value or Distance-To-Go mode, whichever is currently visible.

Data output using external signals

Example 1: Linear axis with radius display X = + 41.29 mm

X	=	+	4 1	.	2 9		R	<CR>	<LF>
1	2	3	4	5	6	7	8	9	10

- 1** Coordinate axis
- 2** Equal sign
- 3** +/- sign
- 4** 2 to 7 places before the decimal point
- 5** Decimal point
- 6** 1 to 6 places after the decimal point
- 7** Unit: blank space for mm, " for inches
- 8** Absolute display:
 - R** for radius, **D** for diameter
 Distance-to-go display:
 - r** for radius, **d** for diameter
- 9** Carriage return
- 10** Blank line (Line Feed)

Example 2: Rotary axis with degrees decimal display

C = + 1260.0000°

C	=	+	1 2 6 0	.	0 0 0 0		W	<CR>	<LF>
1	2	3	4	5	6	7	8	9	10

- 1 Coordinate axis
- 2 Equal sign
- 3 +/- sign
- 4 4 to 8 places before the decimal point
- 5 Decimal point
- 6 0 to 4 places after the decimal point
- 7 Blank space
- 8 **W** for angle (in distance-to-go display: **w**)
- 9 Carriage return
- 10 Blank line (Line Feed)

Example 3: Rotary axis with degrees/minutes/seconds display

C = + 360° 23' 45"

C	=	+	3 6 0	:	2 3	:	4 5		W	<CR>	<LF>
1	2	3	4	5	6	7	8	9	10	1	2

- 1 Coordinate axis
- 2 Equal sign
- 3 +/- sign
- 4 3 to 8 places degrees
- 5 Colon
- 6 0 to 2 places minutes
- 7 Colon
- 8 0 to 2 places seconds
- 9 Blank space
- 10 **W** for angle (in distance-to-go display: **w**)
- 11 Carriage return
- 12 Blank line (Line Feed)

Data output using Edge Finder

In the next three examples, measured value output is started with a **switching signal from the edge finder**. Printing capability can be turned on, or off in the Job Setup parameter Measured Value Output. Information from here is transmitted from the selected axis.

Example 4: Probing function Edge Y = -3674.4498 mm

Y		:	-	3 6 7 4	.	4 4 9 8		R	<CR>	<LF>
1	2	3	4	5	6	7	8	9	10	11

- 1 Coordinate axis
- 2 (2) Blank Spaces
- 3 Colon
- 4 +/- sign, or Blank Space
- 5 2 to 7 places before the decimal point
- 6 Decimal point
- 7 1 to 6 places after the decimal point
- 8 Unit: blank space for mm, " for inches
- 9 **R** for Radius, **D** for Diameter display
- 10 Carriage return
- 11 Blank line (Line Feed)

Example 5: Probing function Centerline

Coordinate of centerline on X axis CLX = + 3476.9963 mm (**C**enter **L**ine **X** axis)

Distance between the probed edges DST = 2853.0012 mm (**D**istance)

CLX	:	+	3 4 7 6	.	9 9 6 3		R	<CR>	<LF>
DST	:		2 8 5 3	.	0 0 1 2		R	<CR>	<LF>
	1	2	3	4	5	6	7	8	9

- 1** Colon
- 2** +/- sign, or Blank Space
- 3** 2 to 7 places before the decimal point
- 4** Decimal point
- 5** 1 to 6 places after the decimal point
- 6** Unit: blank space for mm, " for inches
- 7** **R** for Radius, **D** for Diameter display
- 8** Carriage return
- 9** Blank line (Line Feed)

Example 6: Probing function Circle Center

First center point coordinate, e.g. CCX = -1616.3429 mm. Second center point coordinate, e.g. CCY = +4362.9876 mm, (**C**ircle **C**enter **X** axis, **C**ircle **C**enter **Y** axis; coordinates depend on working plane).

Circle diameter DIA = 1250.0500 mm

CCX	:	-	1 6 1 6	.	3 4 2 9		R	<CR>	<LF>
CCY	:	+	4 3 6 2	.	9 8 7 6		R	<CR>	<LF>
DIA	:		1 2 5 0	.	0 5 0 0		R	<CR>	<LF>
	1	2	3	4	5	6	7	8	9

- 1 Colon
- 2 +/- sign, or Blank Space
- 3 2 to 7 places before the decimal point
- 4 Decimal point
- 5 1 to 6 places after the decimal point
- 6 Unit: blank space for mm, " for inches
- 7 **R** for Radius, **D** for Diameter display
- 8 Carriage return
- 9 Blank line (Line Feed)

II - 6 Error Messages

The following table provides a complete list of error messages that may be received from the W1000 DRO.

An explanation of each error message is provided in the following table.

Error	DRO Error Message	Explanation
1	Power was off. Press any key to continue.	W1000 power was just cycled.
2	Contamination & Frequency Error: Press C to clear error.	Contamination, and frequency errors occurred at corresponding encoder. User intervention to monitor, and/or correct the encoder.
3	Contamination Error: Press C to clear error.	Contamination error occurred at corresponding encoder. User intervention to monitor, and/or correct the encoder.
4	Frequency error: Press C to clear error.	Frequency error occurred at corresponding encoder. User intervention to monitor, and/or correct the encoder.
5	Miscount error: Press C to clear error.	Miscount error occurred at corresponding encoder. User intervention to monitor, and/or correct the encoder.
6	Display Overflow error: Move within display range.	The encoder is currently out of the display range specified by the user. Move the encoder to within the display range, or modify the encoder display.
7	Error: The valid range for number of holes is 1-99.	The number of holes defined for the current pattern is out of range. User must adjust the number of holes.
8	Error: The radius must be greater than 0.0.	The user defined radius must be greater than zero to define a circle.
9	Error: The spacing must be greater than 0.0.	The spacing between holes in a pattern must be greater than zero to define a pattern.
10	Error: The start and end points can not be the same.	The start, and end points of the field must be unique to define a line.
11	Error: The distance from the center is not equal to the radius.	The distance from the center value is invalid, and must be modified by the user.
12	Error: The ARCCOS function can only operate on values from - 1 to 1.	Range error on the value to fetch the arccos of.

Error	DRO Error Message	Explanation
13	Error: The ARCSIN function can only operate on values from - 1 to 1.	Range error on the value to fetch the arcsin of.
14	Error: The TAN function is undefined at 90, and -90 degrees.	Range error on the value to fetch the tangent of.
15	Error: The square root of a negative number is undefined.	Can not take the square root of a negative number.
16	Error: Divide by zero error.	Can not divide by zero.
17	Unable to transfer configuration parameters. The external device is not ready.	The external device hooked to the serial port is not working. Check the physical connection, and verify that the serial communications parameters are correct.
18	Error: One or more of the configuration parameters was invalid, and could not be loaded.	The configuration file being imported is corrupt. Import file again. If error persists, import a different configuration file.
19	Error: Parameter was invalid. It has been set to it's previous value.	An invalid configuration parameter was discovered on import, and was reset to the previous value. Check the configuration file that failed, and import again.
20	Error: The valid range for scale factor is -10 to -0.1, and 0.1 to 10.	The current scale factor value is out of range. Adjust the scale factor value to reflect a valid number.
21	Error: At least one axis must be selected for DRO 1.	When defining multiple DRO, and corresponding views, user must define at least one axis for the default DRO 1.
22	Error: The valid range for the error correction factor in parts per million is -99999 to +99999.	Out of range for the error correction factor defined within error compensation. When defining the error correction factor, the user must use the correct range.
23	A program with this name already exist. Proceed?	A program using the current name already exists, and will be written over the existing program. Proceed, or cancel current operation.
24	Program Import Failed.	The user selected program was not imported successfully. Check physical serial connection. Check validity of file. Import again.
25	Error: No current program to clear.	No program to clear is currently selected. Select a program using the UP/DOWN arrow keys.
26	Error: No program to load.	No program is currently selected to load. Select a program using the UP/DOWN arrow keys.

Error	DRO Error Message	Explanation
27	Error: No program to delete.	No program currently selected to delete. Select a program using the UP/DOWN arrow keys.
28	Error: No step function for this step.	Current program step has no functionality defined for it. The step should be modified using the step functions, or deleted from the program.
29	Error: Program storage is full.	There is not enough memory available to add additional programs, or steps to existing programs.
30	Error: Not enough available steps to explode.	Exploding the current step into individual move steps will generate more total steps than allowed per program.

II - 7 Dimensions

DRO Dimensions

Dimensions in inches/mm

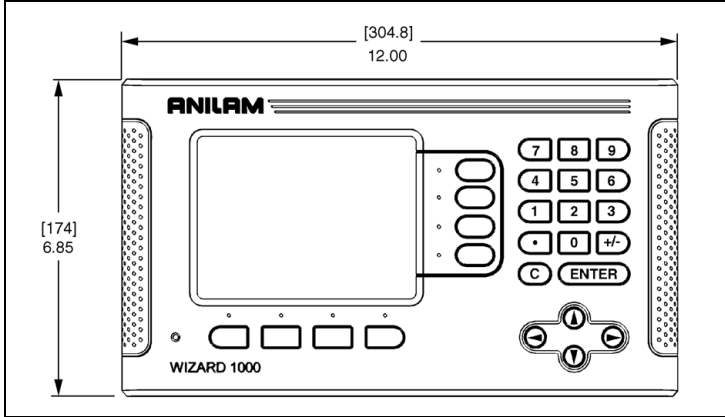

Front view with Dimensions

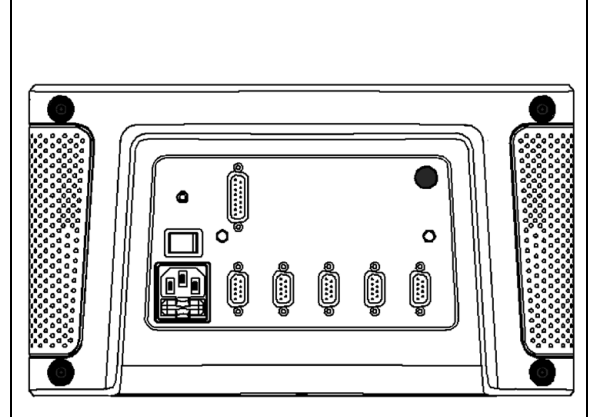

Back view

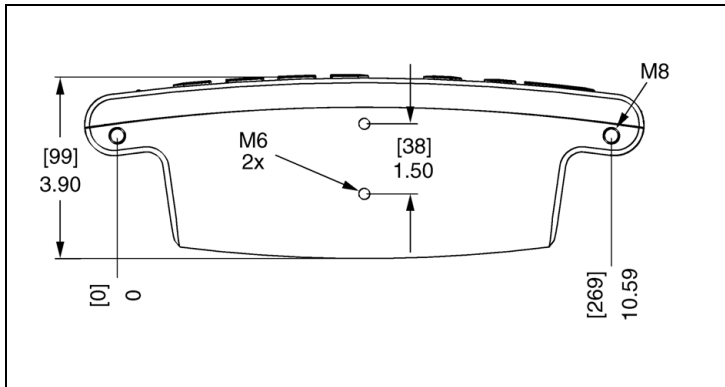

Bottom view with Dimensions

Numerics

1/2 soft key 36

A

Absolute 12
 absolute coordinates 3
 Absolute Distance Preset 33
 Absolute Workpiece Positions 3
 Actual Position, Nominal Position, and
 Distance-To-Go 2
 Actual Value/Distance-To-Go
 soft key 12
 Arc Milling 47
 Automatic Non Linear error 85
 Axis Labels 6

B

Backlash Compensation 87

C

Calc key ii
 Calc soft key 20
 Calling a Tool from the Tool Table
 (Turning) 53
 Circle and Linear Pattern 38
 Console adjustment 19
 Counter Settings 87

D

Data Input Forms 9
 Datum soft key (Milling) 28
 Datum Soft Key (Turning) 53
 Datums 2
 Diagnostics 88
 Diameter Axes (Milling) 14
 Disable Ref soft key 11
 Display Area 6
 Display configuration 81
 DRO Dimensions 102

E

Edge Finder (milling applications only) 14
 Electrical Requirements 91
 Enable Ref soft key 11
 Enable/Disable Ref Function 11
 Encoder Reference Marks 5
 Encoder Setup 79
 Environmental Specifications 91
 Error Compensation 81
 Error Messages 9, 99

F

Features 37
 features 37
 Fundamentals of Positioning 2

G

General Navigation 7
 Graphic Positioning Aid 7
 Grounding (Earth) 91

H

Help Screen 8, 29, 30

I

Import/Export (setting) 19, 23
 Incline & Arc Milling 44
 incremental coordinates 3
 Incremental Distance Preset 35
 Incremental workpiece positions 3
 Index soft key 8
 Installation Setup Parameters 78
 Instruction Box 9

J

Job Clock 15
 Job Setup menu 12
 Job Setup Parameters 13

L

Language (setting) 19
 Linear Error Compensation 82

M

Measured Value Output 15, 94
 Mirror 14

N

Near Zero Warning 15
 No Ref soft key 10

O

Operating Instructions 1
 Operating Modes 7, 12

P

Position Recall 88
 Power Up 10
 Preset 33
 Preventative Maintenance 91
 Probing Functions 28
 Programming 66

R

Radius/Diameter 56
 Reading head position 4
 Ref Symbols 6
 Reference Mark 10
 Remote Switch 17
 RPM Calculator (Milling) 21

S

Scale factor 13
 Screen Layout 6

Serial Port 90
 Set Zero soft key 20
 Setting Tool Offsets 51
 Setup 12
 Setup soft key 12
 Skew Compensation 16
 Soft key Labels 6
 Status Bar 15
 Status Bar Settings 15

T

Taper Calculator 55
 Thread Cycle 59
 Thread Cycle feature 59
 Thread cycle form 61
 Thread Cycle Setup 79, 80
 Thread Cycle Soft Key Functions 59
 Tool data entering 25
 Tool Soft Key 22
 Tool Table 22
 Tool Table (Turning) 51
 Tool Table Usage 25
 Tread cycle form 61, 62

U

Units of measurement, setting 13

V

Vectoring 57
 View Settings 17

Z

Z Coupling 57
 Z/W Coupling 50
 Zero Angle Reference Axis 4



HEIDENHAIN CORPORATION

333 East State Parkway
Schaumburg, IL 60173-5337 USA

 +1 (847) 490-1191

 +1 (847) 490-3931

E-Mail: info@heidenhain.com

www.heidenhain.com

**ISO 9001
CERTIFIED**

